

THE BAADER PLANETARIUM



INSTRUCTION MANUAL

baader[®]
planetarium

BAADER PLANETARIUM GMBH

Zur Sternwarte • 82291 Mammendorf • Tel. 08145/8802 • Fax 08145/8805
www.baader-planetarium.de • kontakt@baader-planetarium.de • www.celestron-deutschland.de

HINTS/TECHNICAL

1. YOUR PLANETARIUM OPERATES BY A DC MINIATUR MOTOR. IT'S LIFETIME IS THEREFORE LIMITED. PLEASE HAVE THE MOTOR USUALLY RUN IN THE SLOWEST SPEED POSSIBLE. FOR EXHIBITIONS OR PERMANENT DISPLAY A TIME LIMIT SWITCH IS A MUST.
2. DON'T HAVE THE SUNBULB WORKING IN THE HIGHEST STEP CONTINUOUSLY. THIS STEP IS FORSEEN ONLY FOR PROJECTING THE HEAVENS IF THE PLASTIC SUNCAP IS REMOVED.
3. CLOSE THE SPHERE AT ANY TIME POSSIBLE.

HINTS/THEORETICAL

1. ESPECIALLY GIVE ATTENTION TO PAGE 5-3.F OF THE MANUAL.
2. CLOSE THE SPHERE SO THAT THE ORBIT LINES OF THE PLANETS INSIDE FIT CORRECTLY PAGE 6-5.A.
3. USUALLY DEMONSTRATE BY KEEPING THE EARTH'S ORBIT HORIZONTAL.
4. A SPECIAL EXPLANTATION FOR THE SEASONS IS POSSIBLE IF YOU TURN THE SPHERE TO A HORIZONTAL CELESTIAL EQUATOR. NOW THE EARTH MOVES UP AND DOWN ON ITS WAY AROUND THE SUN. MENTION THE APPEARING LIGHTPHASES.
5. REMEMBER THE GREATEST FINDING OF COPERNICUS: THE DISTANCE EARTH - SUN IS NEARLY ZERO COMPARED TO THE DISTANCE OF THE FIXED STARS. IN REALITY THE WHOLE SOLAR SYSTEM IN THE CELESTIAL SPHERE WOULD BE A PINPOINT IN THE CENTER. THIS HELPS TO UNDERSTAND THE MINUTE STELLAR PARALLAXE AND THE "FIXED" POSITION OF THE STARS COMPARED TO THE SUN'S CHANGING HEIGHT OVER THE HORIZON DURING THE YEAR.

INTRODUCTION

For countless centuries the stars have been objects of mystery. They have fascinated men everywhere. Systematic observations of the skies began with the onset of civilization. They have continued and expanded to the present time. Man has conquered many unknowns of the past. Today as he surges toward a more complete understanding of the universe, he uses space probes that travel to the more distant planets of the solar system in his continuing quest for knowledge.

Landings on the moon and the nearer planets have been accomplished. Laboratories in space are designed for continuous use in research. With this progress, increasing numbers of persons are dedicating their efforts to science and to the conquest of space. Today's youth are faced with concepts and phenomena that will influence their lives and welfare in the years to come.

THE BAADER PLANETARIUM provides you with an abundance of educational possibilities. After you have experimented with the planetarium as suggested in the instructions, you will appreciate it for its numerous educational uses.

The planetarium can be used by large and small groups of students, or by individuals. Demonstrations explaining the mechanics of our solar system were once reserved for the largest planetariums. Now anyone who seeks explanations for the multitude of celestial phenomena can benefit from the use of this relatively small planetarium.

CONTENTS

Key to the parts	4
Assembly of the Planetarium	5, 6
Description of the Planetarium	7
Phenomena studied with the Planetarium	8
Demonstrations with the Planetarium	8
Solar system	9
Direction of rotation and revolution	10
Seasons	11
Day and night, length of the day	11, 12
Phases of the moon	12
Eclipses	13
Synodic and sidereal time	14
Seasonal stars	14
Setting the globe for your location	14
Galactic motion	16
Projecting the stars	16
Stars of summer	18
Stars of winter	20
Constellations	22, 23
Platonic year	24
Additional concepts	24

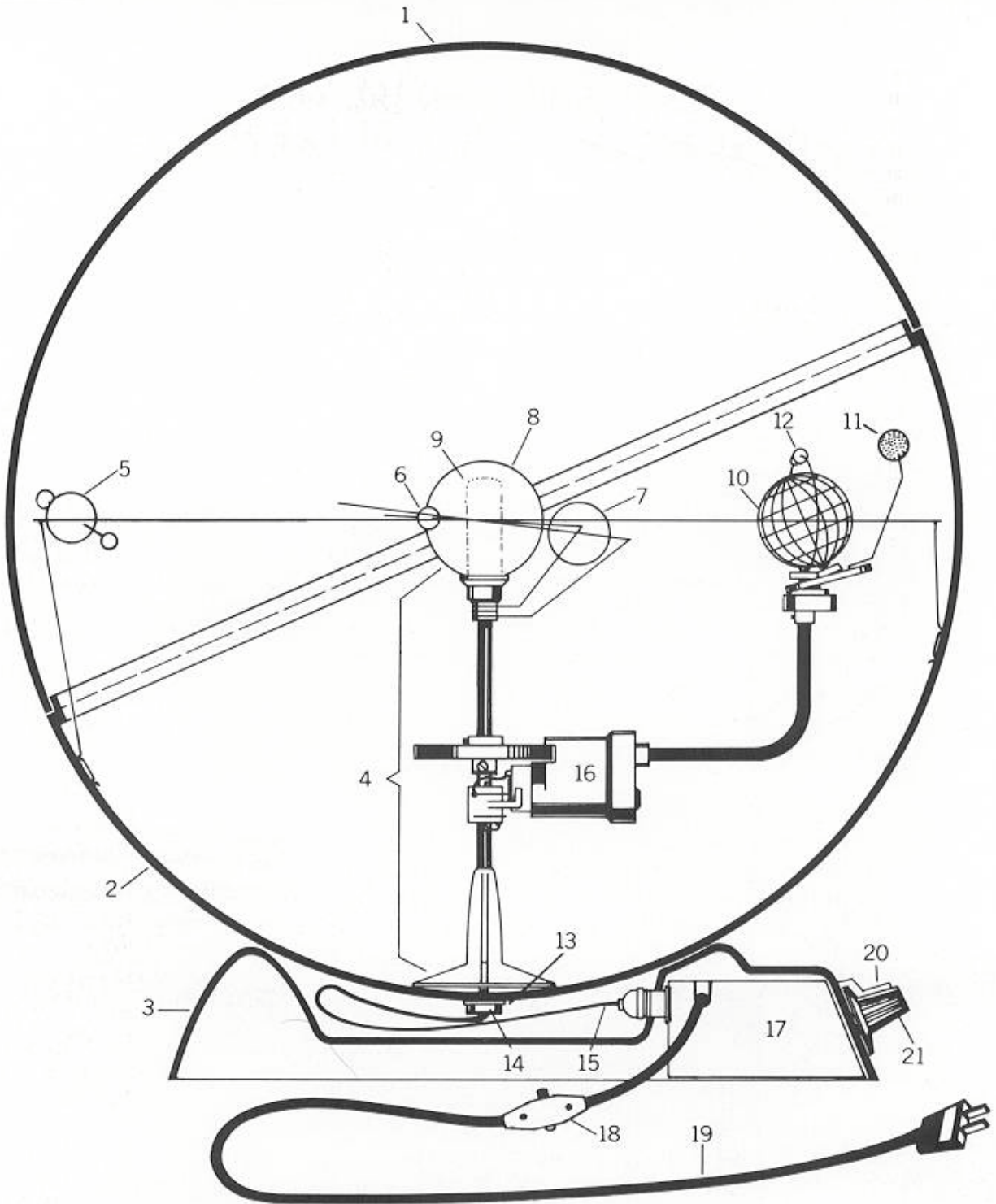

KEY TO THE PARTS

- 1. Northern Hemisphere
- 2. Southern Hemisphere
- 3. Base
- 4. Sun Assembly
- 5. Mars Assembly
- 6. Mercury Assembly
- 7. Venus Assembly

- 8. Sun Globe
- 9. Electric Lamp
- 10. Earth Globe
- 11. Moon
- 12. Space Craft
- 13. Split Washer
- 14. Retaining Cap Nut

- 15. Power Lead
- 16. Motor
- 17. Transformer
- 18. Switch
- 19. Line Cord
- 20. Light Control
- 21. Motor Control

ASSEMBLY OF THE PLANETARIUM

THE BAADER PLANETARIUM IS A PRECISION INSTRUMENT AND MUST BE HANDLED AND ASSEMBLED AS OUTLINED IN THE FOLLOWING INSTRUCTIONS:

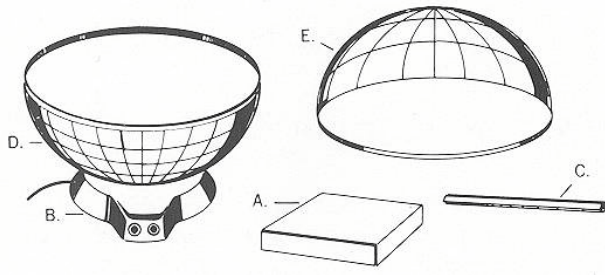

1. CAREFULLY UNPACK PLANETARIUM

REMOVE -

- A. Box with sun assembly
- B. Black base
- C. Constellation foil
- D. Southern hemisphere (placed in base)
- E. Northern hemisphere

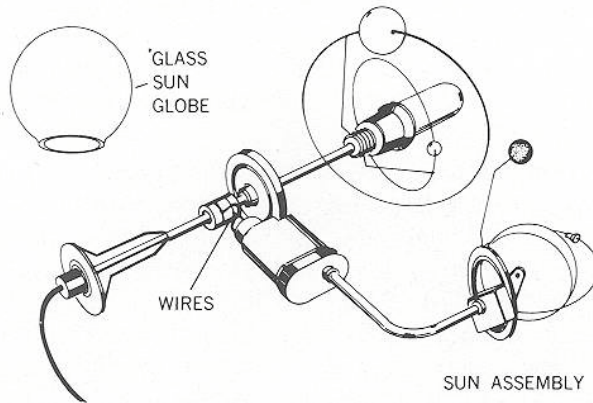

2. CAREFULLY UNPACK SUN ASSEMBLY

- A. Remove sun assembly carefully. Do not damage wire connections
- B. Unwrap glass sun globe

3. ATTACH SUN ASSEMBLY TO SOUTHERN HEMISPHERE

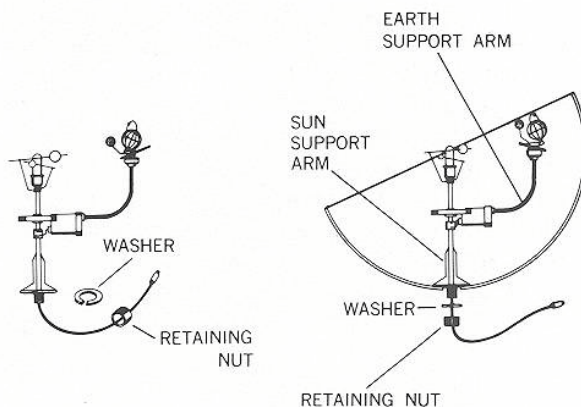

- A. Unscrew retaining nut and slide down cord
- B. Remove washer from cord
- C. Place cord and assembly into hole in southern hemisphere

- D. Replace washer onto cord outside hemisphere
- E. Carefully thread retaining nut onto support. **MAKE CERTAIN NOT TO STRIP THREADS**

- F. **TWIST SUN SUPPORT BASE** until grids on earth are parallel to grids on celestial sphere. **DO NOT TURN EARTH SUPPORT ARM MANUALLY**

4. CHECK LIGHT AND MOTOR OPERATIONS

- A. Carefully snap glass sun globe onto light clip
- B. Insert sun assembly cord plug into socket in globe base and attach main cord to 110 Volt outlet
- C. Turn right knob on base to test 3 way-light
- D. Turn left knob on base to test motor drive. Motor operates at variable speeds forward and reverse

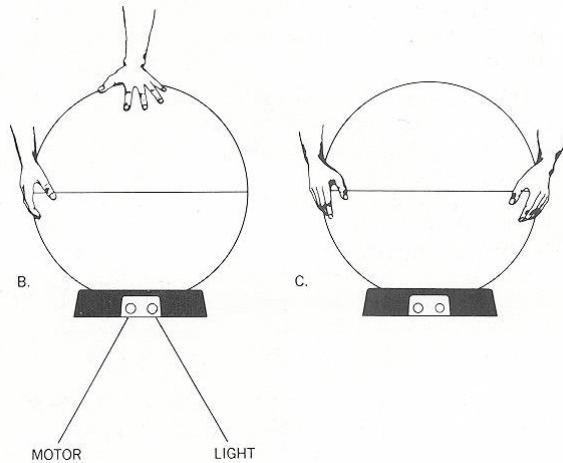

1. ATTACH NORTHERN HEMISPHERE

- A. Place northern hemisphere onto equator rim and align grid lines
- B. Close with palm of hands on top of the globe
- C. To remove northern hemisphere lightly press with both hands on the sphere near the equator

6. OPERATING THE PLANETARIUM

- A. For CONTINUED OPERATION motor should operate at SLOW SPEED.
- B. For CONTINUED OPERATION light should be set at MIDDLE BRIGHTNESS.
- C. To project stars, glass sun globe must be removed.
- D. Printed constellation figures may be cut out and taped onto outside of globe for projection.
- E. Inner planets may be rotated around sun by moving wire supports.

7. REPACKING PLANETARIUM FOR STORAGE OR SHIPMENT

- A. Place foam pad in bottom of carton.
- B. Place northern hemisphere in carton.
- C. Place southern hemisphere inside northern with foam separators.
- D. Place foam pad inside southern hemisphere.
- E. Place black base upside down on foam pad with foam protector over knobs.
- F. Pack sun assembly into sun assembly box. MOON MUST BE BETWEEN EARTH AND SUN (SOLAR ECLIPSE). USE MOTOR TO POSITION SUN. Avoid damaging wire connections. Wrap glass sun globe in foam.
- G. Place sun assembly box on top of base and insert constellation foil. Replace, top foam pad.

ADDITIONAL ASSEMBLY INSTRUCTIONS

WHEN INSTALLING the unit, be certain that the fine wires around the sun and earth are not accidentally damaged. The long and thin cable leading to the sun should be inserted properly through the small hole on the southern half of the sphere. In addition, the threaded sun mount must be inserted into this same hole to permit a secure installation of the socket into the sphere. Insertion of the five-prong plug into the sphere's base takes place after the above steps have been completed. The long cable permits rotation of the sphere in all directions during demonstrations and when operating the control switches.

THE WASHER with the small slot is attached to the unit in such a manner, as to rest against the bottom of the sphere, after being slipped over the cable (see diagram). With the washer in place, the nut is carefully fastened, securing the inside mount onto the sphere. To permit quiet operation, the base is constructed of flexible material. Be careful not to damage the plastic threading.

EVEN IF the nut is tightly secured, you can rotate the earth-sun mount independently from the sphere. Now turn the mount in such a manner, that the divisions of longitude and latitude of the earth coincide optically with the same divisions on the outside of the globe. When making this adjustment, be sure you only touch or turn the plastic base of the sun mount. Under no circumstances should the earth mount be turned or adjusted, since that would result in damage to the delicate gears located in the support arm of the earth.

BE CAREFUL NOT TO BEND OR TWIST THE THIN WIRES OF THE MOON AND MAN-MADE SATELLITE!

THE MOTOR AND GEARS of your PLANETARIUM are the result of precision engineering and excellent craftsmanship. Please handle interior mount and gears with the utmost care required for such a delicate mechanism. When cleaning the plastic sphere, use a nonstatic cloth, of the type used for treating records. The base of the planetarium should be cleaned in the same manner.

EVEN THOUGH the materials used in constructing the planetarium are of highest quality, you should handle the sphere with due care. Please take precautions against grasping the edges of the sphere when handling the unit. Although the globe is resistant to shocks, take special precautions against dropping the lower half of the sphere.

WHEN SEPARATING the two halves of the sphere, lightly press with both hands on the side of the sphere near the partition. By this operation the northern hemisphere will be ejected. For convenience, open and close the sphere in a horizontal position. During demonstrations, or when rotating the sphere, handle the unit in such a way that the separation will not occur accidentally.

BE CAREFUL WHEN CLOSING THE SPHERE! Place the northern hemisphere upon its southern counterpart, so that the sphere is nearly closed. Check whether the outside graduation of the sphere coincides. To complete the closing operation, PLACE ONE HAND ON TOP OF THE NORTHERN SPHERE AND APPLY PRESSURE DOWNWARD AND TOWARDS THE LAST REMAINING OPENING. (IMPORTANT) Should this pressure be insufficient, then apply direct pressure and if necessary CAREFULLY push against the remaining opening. The sphere should now snap closed. Closing the sphere is somewhat difficult, although you will accomplish this operation after some practice.

DISCRIPTION OF THE PLANETARIUM

The operation of your BAADER PLANETARIUM is based on the principle that the gray-black plastic reflects 98% of any impinging light. It is because of this property, that the sphere appears completely black when viewed in direct light. Place the sphere in a corner of a room opposite to the source of light (for example a window).

In a darkened room, the human eye will be able to see through the sphere, once the artificial sunlight is turned on. The planetarium's construction now permits you to view the inside of the sphere from all sides, although the interior opposite to you will be opaque and appears black. You can now observe the earth with its orbiting moon moving across a black and starfilled sky. The sphere's materials and construction causes this interesting effect, permitting two persons on opposite sides of the sphere to view the interior of the planetarium, but not being able to see each other.

Please note that your BAADER PLANETARIUM will properly function to your fullest satisfaction when viewed in near darkness, enabling you to project the constellations onto the ceiling or walls.

Physical limitations do not permit developing a scale model with the exact proportions and distances as in nature. Your BAADER PLANETARIUM will however magnificently show the motion and relationships found in space. With your planetarium you can demonstrate the more easily understood relationships, such as the moon's phases or the seasons of one year. Complicated relationships can be mastered as well, enabling you, for example, to explain and demonstrate why we see the stars in different positions throughout the year. The exterior of your BAADER PLANETARIUM is a conventional celestial globe. When viewing the outside, this globe-like all celestial globes will show the heavenly bodies in reversed order. It is when you study the constellations by looking inside the sphere, that you are in a position to see the heavens as they appear

in nature. This property makes your BAADER PLANETARIUM unique, for it is the only celestial globe and map available anywhere, showing the stars on a black background in their proper perspective.

We have chosen an „equator“ graduation commonly found on celestial globes. That system transfers the earth's graduation onto the heavens, permitting you to continuously check whether the earth is in a correct position with the sphere. Both graduated scales must lie parallel to each other.

We now know that the size relationships found in space are infinitely large and appear to lie outside the imagination of man. We must measure distance in space - even for our immediate vicinity in light years (1 light year = approx. 6,000,000,000,000 miles), in order to facilitate some kind of description. We all know that interplanetary vehicles, traveling from earth to one of our solar planets (such as Venus or Mars), require several months to reach their destination-moving with a speed greater than 18,000 mph. **The size of the planets and distance involved will explain why the scale found in the BAADER PLANETARIUM cannot be completely true to nature.** Similarly, the relative size of the sun and the small model earth had to be compensated. With a **model earth having a 13/8 inch diameter**, the sun would have to be about **one hundred times as large, or 11 feet 5 inches.**

Just as it is unpractical to attempt a true scale model of our solar system, it would be futile to show the moon and its natural orbital inclination to the earth. **It was therefore necessary to show the angular position of the moon's orbit compared to the earth somewhat exaggerated**, thereby showing the phenomena of a **full moon and eclipses in the model solar system. The revolutions of the earth and moon were reduced**, so as to permit clear observation of the continents during demonstration. These **necessary reductions** were carried out in a manner causing the earth to rotate once in a month meaning that the year has a duration of twelve days (one month has one day). The moon shows three synodic orbits during that time, with the earth orbiting the sun in about four minutes. Therefore, one year lasts about four minutes in the BAADER PLANETARIUM (during slow operation), although the model earth may be accelerated to bring it into any desired position.

PHENOMENA STUDIED WITH THE PLANETARIUM

The observer may study the following phenomena:

- lunar and solar eclipses
- full and new moon the phases of the moon and its position in regard to
- the starry sky
- the unit makes clear how the seasons of the year are brought about (spring, summer, autumn, winter) and in turn polar night and day
- the changes in the length of day and night
- changes in the nodes of the moon's path around the earth
- the path of a satellite, which travels through space with the revolving earth and orbiting moon.
- how the different stars are seen from the earth during various seasons
- the formation of the declination and right ascension angulars during the year and during a night
- sidereal, synodic and draconitic time
- the formation of movement from the circumpolar stars
- the platonian year
- the heavens for each night and each hour of the year
- the movement of the moon about the sun
- the orbit of the earth observed as a moving shadow
- across the projected firmament during projection of the constellations onto the ceiling and walls after lifting off the sun globe the relationships of projected symbolic diagrams of the constellations (such as the Big Bear)

DEMONSTRATIONS WITH THE PLANETARIUM

Before beginning the demonstration, show the observer **the closed sphere of the planetarium under direct light**. The sphere appears opaque and has the **properties of a celestial globe**, enabling the viewer to

study the major constellations in a manner similar to conventional globes. **At this point it should be made clear that all celestial globes viewed from the outside present the heavens in reverse order.** This drawback is caused by the fact that man sees the natural heavens as an arched firmament, whereas the celestial globe observed from the outside necessarily shows the same image in reverse order.

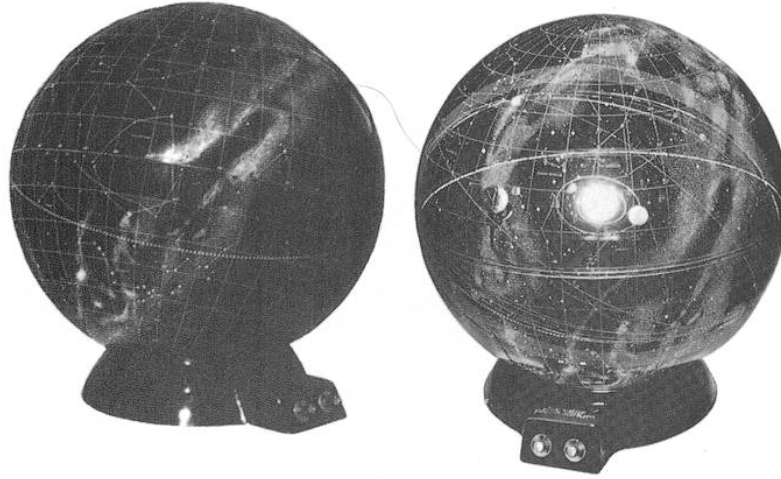

Now turning on the small, artificial sun on the inside of the Baader Planetarium will bring **about an amazing effect.** In a somewhat darkened room, the previously **opaque sphere becomes transparent**, and it is possible to **look into the sphere from all sides.** At this time the globe should be positioned so that the earth's orbit is horizontal. In cases where it is impossible to reduce the illumination of the demonstration room, the observer must approach the sphere very closely (shielding off any infalling light from the side with his hands), in order to see the irinside of the once opaque celestial globe. It should be pointed out that this effect **enables the observer to see the light stars against a black sky and in a unique true to nature manner found only in the Baader Planetarium.**

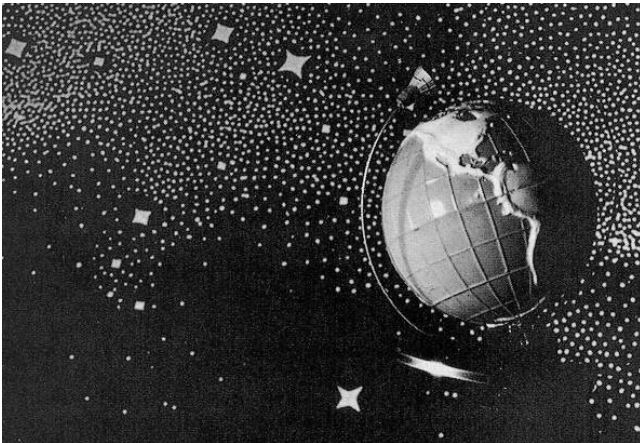

The observer has the feeling as if he were **actually looking up into the heavens at night** - seeing the stars on an **arched, black firmament and in their correct perspective.** Now the various demonstrations should be started. The top (northern) half of the sphere can be removed to facilitate the first explanation.

SOLAR SYSTEM

The observer now sees the solar system in space, and it should be made clear at this point that the small lamp in the center represents our sun. The two inner wire orbital paths represent the planets Mercury (requiring 88 days for one revolution around the sun), and Venus (requiring 225 days for one revolution). The third planet from the sun is our Earth, which is seen with its moon as a movable model. Fastened to the lower half of the sphere is a wire orbital path of the fourth planet in our solar system that being Mars (requiring 687 days for one revolution around the sun).

With the sphere being open, it is easy to explain the position and the similar plane of the planets as they move around the sun. These observations can be made easily by comparing the wire orbits and the model earth. **The observer should now be told that the orbits of the exterior planets Jupiter, Saturn, Uranus, Neptune, and Pluto, as well as the planetoid (asteroid) belt, are printed on the inside surface of the globe.**

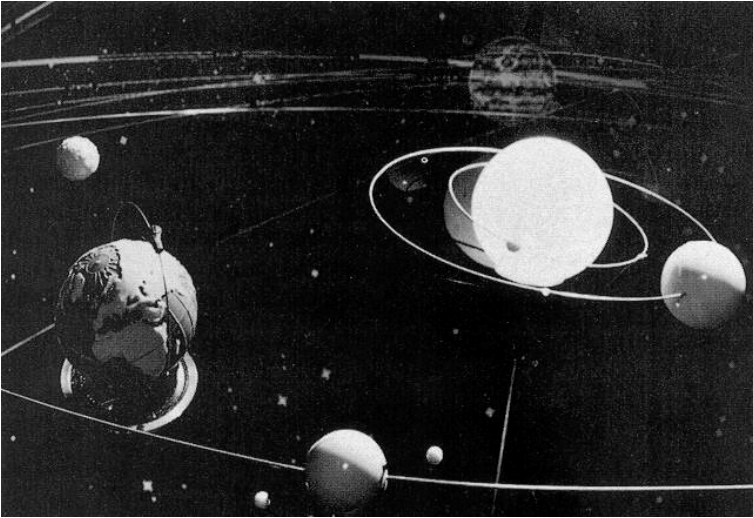

It should also be noted that these illustrated orbits continue on the top half of the sphere (previously removed), and that this clearly shows the relative plane and position of the planets.

All of the planets therefore **are seen to be lying on a plate-like plane**, the only exception being the planet Pluto. Scientists are led to believe that the planet Pluto is under the influence of unknown gravitational forces, having an influence on its path around the sun.

DIRECTION OF ROTATION AND REVOLUTION

The next step in a demonstration is the explanation **that all big orbits** found in our solar system **have the same direction**. To observe that phenomena, we must choose a **reference point** for our observation, **that being from the north or top** of the sphere. Looking down into the planetarium in such a manner, we note that the earth rotates on its axis in a **counterclockwise fashion**. Similarly, the **moon moves counterclockwise** in its orbit around the earth. The earth also moves counterclockwise around the sun in completing one year, **just as all orbital movement of the other 8 planets is in that same direction in our solar system**. This phenomena is consequently a strong evidence for the theory stating that our solar system evolved out of a gyrating mass of gases.

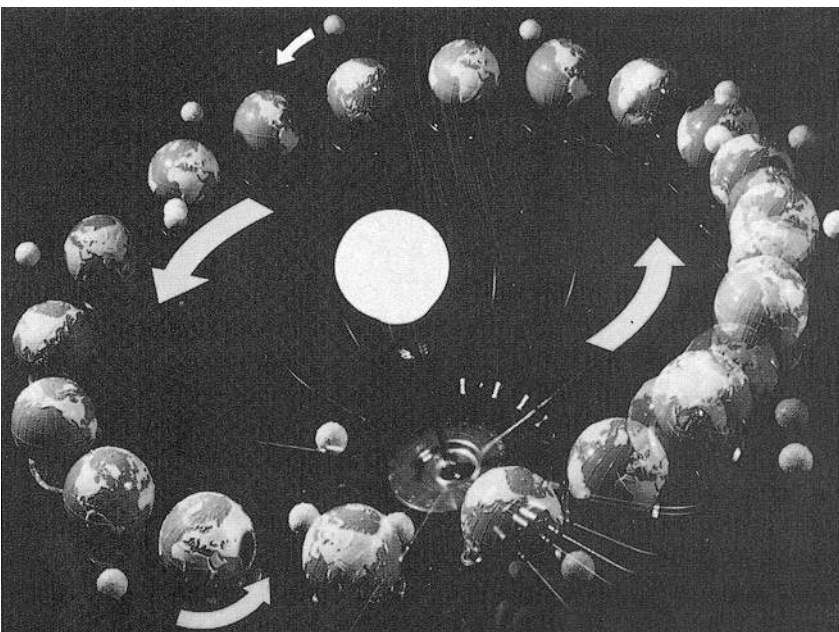

That theory assumes that **intergalactic gases** were brought to a **rotating motion** due to some gravitational forces, increasing in density and speed over time that process led to the formation of „solid“ bodies **revolving around a condensation center** that being our sun. This theory on the formation of our solar system is quite feasible and has found wide acceptance today.

SEASONS

Continuing the demonstration, the illumination phases of the earth making up one year during its revolution around the sun should be explained. Whether the planetarium should be closed (top half again placed on the planetarium) for further study depends, on the particular demonstration and how well the room can be darkened. With the sphere closed, it is easier to shield off infalling light and the observer will more easily see the various phases during the demonstration.

It must be pointed out that the **rotation of the earth** around its own axis **results in a gyrating top-like effect**, thereby maintaining its relative position in space. However, the careful observer will note that the north/south axis of the earth is not vertical on its moving path. That means that the earth's axis, relative to its orbit around the sun (ecliptic), **has an angular tilt of 23.5°** . The Baader Planetarium clearly shows **the same phenomenon** and the observer is able to see the tilted axis of the earth in its orbit around the sun. When demonstrating this latter effect, it may be helpful to show the whole process by using one's hand in explaining how the tilted earth revolves around the sun always keeping its constant tilt. When the observer keeps these principles in mind and watches the small model earth during the orbit around the sun, it becomes quite clear how the **tilted axis of the earth results in the changing areas of sun illumination and seasons on our planet.**

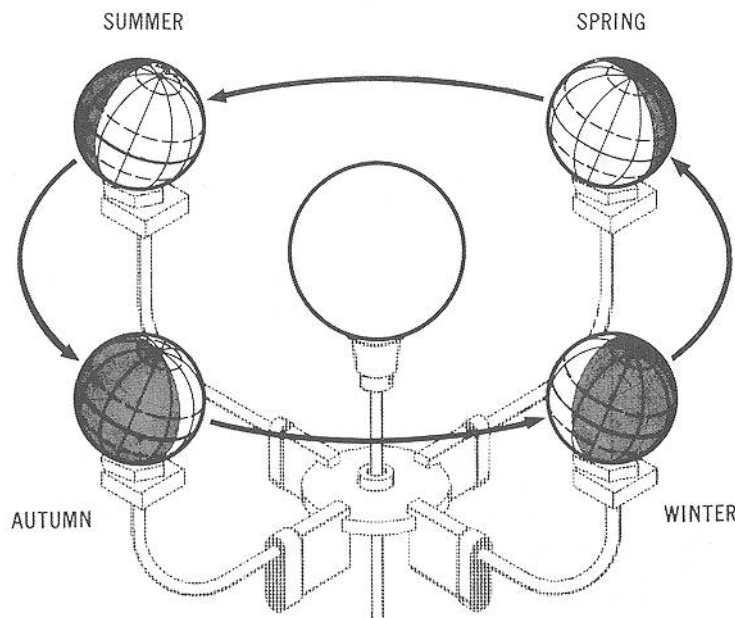

After having pointed out that the earth's distance from the sun varies during the course of one year due to the elliptic nature of the orbit, it becomes **necessary to explain the nature of the seasons. The four seasons are only caused by the angular tilt of the earth's axis** during its orbit around the sun. To demonstrate this phenomenon, we watch the planetarium in operation looking down into the sphere from the north.

DAY AND NIGHT

The phenomena of day and night results from one side of earth facing the sun (day), while the opposite side undergoes a dark period (night). The earth with its orbiting moon rotates on its axis, and at the same time orbits around the sun as the center of our solar system.

It would be nearly impossible to present a true scale model of the orbiting earth and its 365 revolutions. The result would necessarily be a small earth turning at relatively high speed. Therefore your Baader Planetarium shows 12 rotations for each orbit around the sun, with nearly 3 synodic orbits of the moon occurring at the same time.

The time of day, as well as international time zones, will become clear, when watching the model earth rotating on its axis and seeing whole continents moving continuously from day into night. You will easily understand how a difference in time results, when flying from New York to London.

LENGTH OF DAY

We note that the small model earth orbits the sun in a counterclockwise direction, **completely illuminating the North Pole** at one point (North America-summer) and resulting in the eternal polar day. At the opposite point in its orbit, the **North Pole of the earth lies in darkness** (North America winter), causing the eternal polar night. Attention should be called to the fact that **in winter, North America passes through a short daylight zone**, with night being long. In contrast, these **conditions are reversed** on the opposite side of the earth's solar orbit **as is the case in the month of June**. The night zone in which the continent of North America experiences darkness is much smaller (a short summer night). In turn, the distance traversed during daylight is now very long and sunrise occurs as early as 4 A.M.

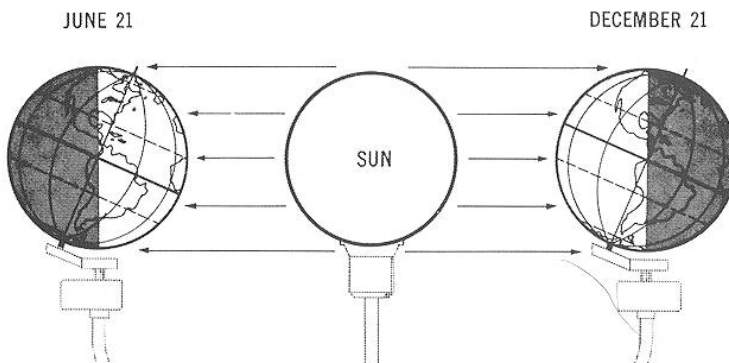

An explanation should stress the fact that the **length of night and day is not the determinant for summer**, but that the **angularity of the sun's illumination has the major influence**. When observing the earth's northern hemisphere during winter, it will become clear that the angularity of the sun's rays is flat and consequently results in yielding less warmth and intensity in contrast to the more direct illumination found in summer.

During that season, the rays of the sun fall more directly and therefore with greater intensity upon North American latitudes. From experience everyone knows that during winter the sun stays near our visual horizon. During summer, the sun passes more directly over us at maximal zenith.

(Note that this demonstration will only succeed if the support of the earth and sun has been aligned according to the provided instructions on page 3. The graduation of latitude and longitude must be parallel for the earth and with the divisions found on the outside of the sphere. The celestial equator and that of the model earth must lie in one plane).

PHASES OF THE MOON

Continuing the Demonstration, **the occurrence and visibility of the lunar phases may be explained**. Set the speed of the model as slowly as possible for demonstrating lunar phases. Again the observer is required to imagine himself on one particular spot on the model earth, looking upward into the heavens from that location.

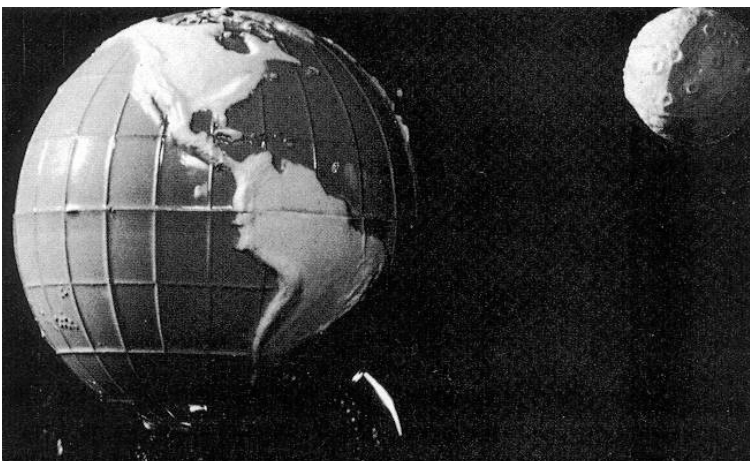

The moon's phases will be seen when looking in a direct line over the earth and toward the moon. When watching lunar phases, it is quite instructive **to point out the occurrence of a new moon or one in its last quarter**. The phases of the moon can best be studied, if you imagine yourself as being on one particular location on the earth. From that spot you can view the moon and watch the phases and their development. You will see the varying proportions of illumination, as the moon passes from one phase to another. In addition, the shape of the moon's image changes continuously.

ECLIPSES

Lunar eclipses and periods of a full moon take place independently during the moon's orbit of the model earth. Following an occurrence of a lunar eclipse, it will prove practical to explain the reasons for a new moon. **A new moon means**, that the moon is positioned exactly on an imaginary line between the earth and the sun. Consequently, the moon is obscured and cannot be seen for one night. It is curious that everyone knows the term „new moon“ but that most people are at a loss as to where the moon is actually located at that time.

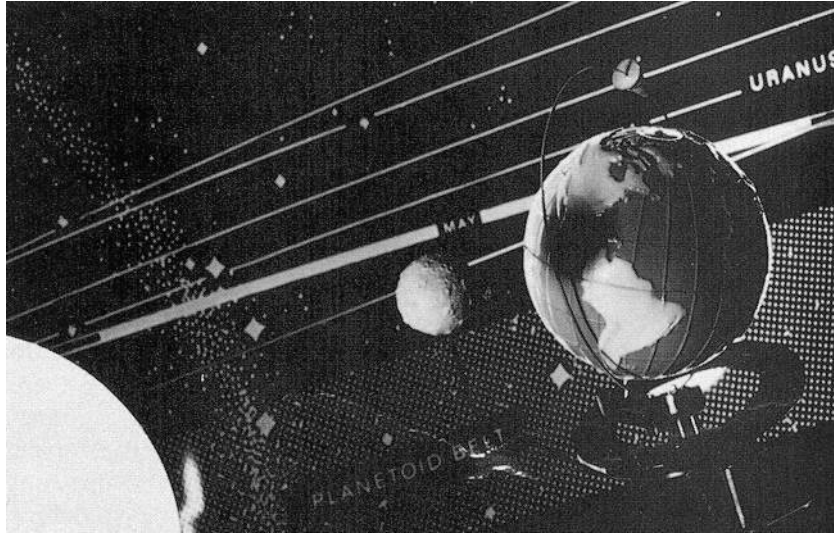

Having shown the principle of the new moon, another important demonstration becomes possible that of a solar eclipse. It is here that the shadow of the moon can be watched easily as it passes over the surface of the earth.

Eclipses can be observed in their full beauty with your Baader Planetarium. True to nature, the intricate gears of the moon's mechanism change the relative position of each orbit and cause an eclipse to occur at various locations on the earth. We are able to **demonstrate the occurrence of a solar eclipse** on earth, also **showing the zones of total darkness (umbra)** and **those under a partial eclipse (penumbra)**. The complex changing motion of the Baader Planetarium permits an explanation why some solar eclipses cover a large area of our earth, while others include only relatively small locations. Such phenomena are given a clear explanation by the visible orbital path of the moon, relative to the position of the earth.

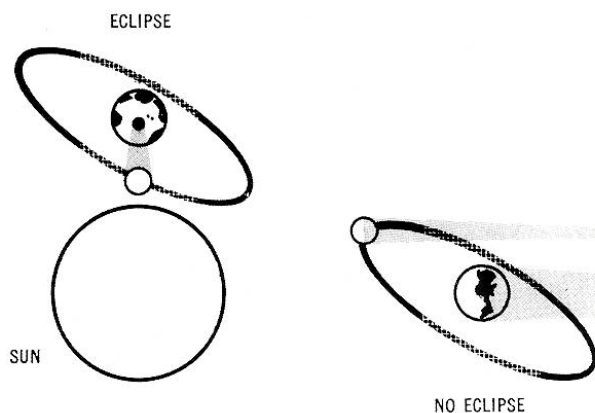

Changes of the Lunar Nodes are caused by an offset chrome ring in your Baader Planetarium. Compare the motion of this ring to that of the earth. You will see that in contrast to the movement of the earth and moon, the chrome ring describes an orbit contrary to all other motions. The ring, were it located at the earth's equator, would symbolize the path of the moon. The constant reversal of the orbit and therefore of the nodes is the reason for the continuous changes in lunar and solar eclipses. Were the path of the moon in relation to the earth absolutely constant, it would result in always bringing about similar solar eclipses on the earth.

SYNODIC AND SIDEREAL TIME

The small earth of the Baader Planetarium imitates the mechanics of nature and during a certain period the small earth orbits the sun. After reaching its orbital starting point, one „year“ has passed. In demonstrating this relationship, we can place a coin on a table and move this same coin (earth) around an imaginary sun. By placing one finger on top of the coin and moving it around the chosen „sun“, we note that after a quarter revolution we need to adjust the coin by a quarter turn if we desire the coin to face the sun in the same position on all points of its orbit. In one complete orbit around the sun, the coin will necessarily describe a complete revolution in its horizontal plane. The same phenomena occurs when you divide the circle into 365 parts and rotate the coin similarly 365 times around itself. You will note, that the coin now needs to be adjusted by 1/365th of a turn. Consequently this is the relationship of the earth's day measured from one noon to the next, and necessarily is about 4 minutes longer than if the same day were measured by the stars, as is the case with sidereal time.

In showing these complicated light effects of the sun and the earth, another major point must not be overlooked. Every observer understands that day and night is caused by the sun illuminating one side of the earth, while the opposite side is in darkness.

SEASONAL STARS

Our revolution around the sun constantly brings different sections of the heavens into view at night. For the first time the observer or student really receives a visible explanation why different sections of the starry sky become visible during the course of one year. At the same time, the observer sees how the small earth moves past one section of the sky, while rotating on its axis during the period of one night.

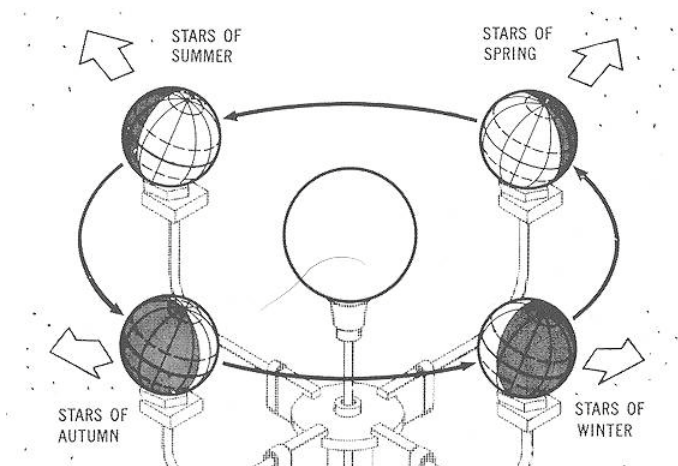

From these insights, **one quickly comprehends why the stars seem to „move across the sky“ at night.** With some advanced understanding, it will also become clear why the angles (i.e. „shooting the stars“) to the stars, as measured from the earth, constantly change during the year and during one single night.

SETTING THE GLOBE FOR YOUR LOCATION

Adjusting the sphere to your own location is achieved by bringing in line the polestar of the planetarium with the same star in nature. Rotate the sphere on the axis described by the North and South Pole, until the desired month appears on the highest point of its meridian. Now place the cardboard ring horizontally on the sphere. The upper visible half of the globe will match the midnight sky on the 15th day of the particular month desired. If you now imagine dividing the particular area in question (one month) into 30 sections, you have an image of how the skies will appear on the particular day of a given month.

Projecting your line of vision from the position of the artificial sun (center of the sphere) to the desired star on the sphere, you can continue that imaginary line and should find the same star in the natural sky above.

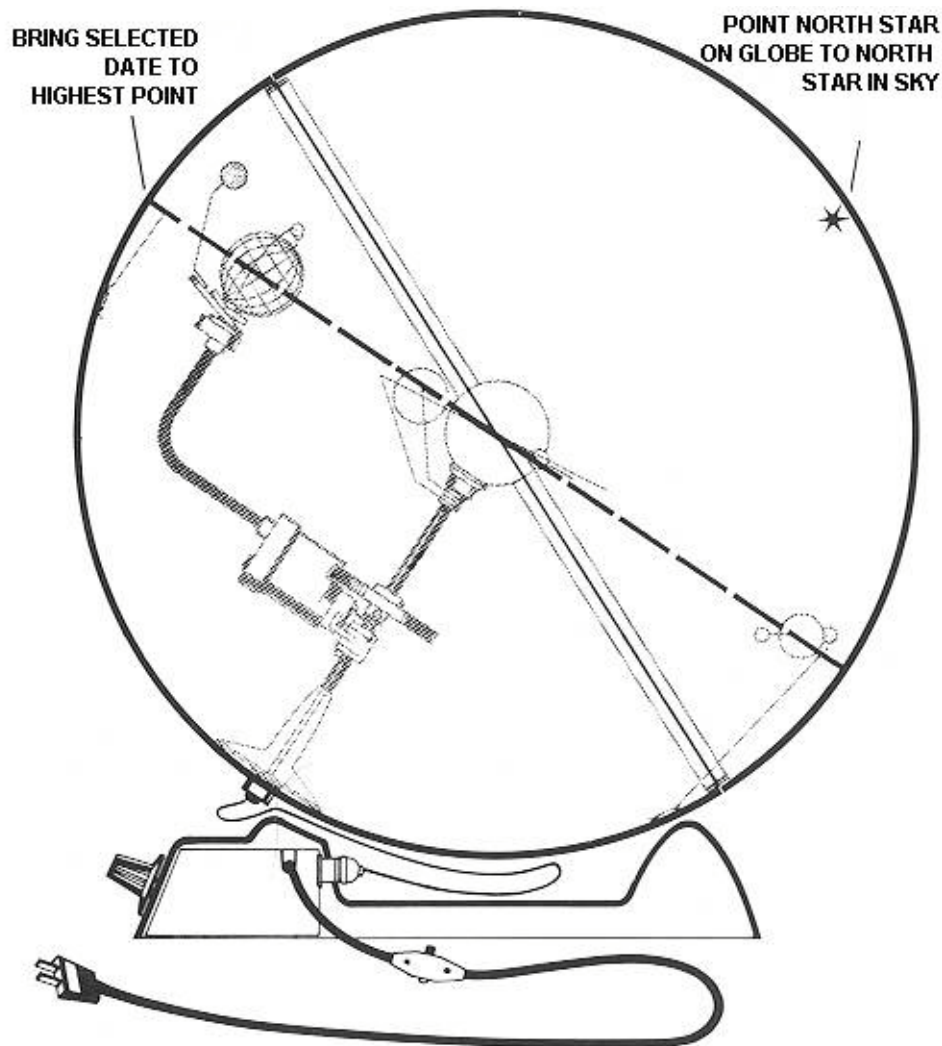

This effect can be best observed when taking the planetarium outdoors on a clear summer night. The hour graduations of the sphere shows the changes of the stars for each hour.

For the first time you are able to see the heavens in their black spherical likeness and as an arched firmament, permitting you to see which constellations are visible where and when.

The position of the stars is true to nature, when looking inside the lighted sphere. Locating particular stars will be easier than with conventional celestial maps. Accustom yourself to noting the direction of particular stars, and you will later find these same stars in a natural sky with amazing accuracy. Project imaginary lines and angles from familiar constellations (such as the Sig Bear), to aid you in later finding these stars on the natural heavens. Whenever needed, take along the northern half of your sphere when viewing outdoors.

The circumpolar stars and their movement around the polestar will be easily apprehended, when observing the earth's orbit around the sun during one year.

The dark side of the earth (night) always faces a certain section of the sky and it becomes obvious why different stars can be seen in different seasons. As an aid in determining the particular section of the sky matching the season in question, you can cut out a cardboard ring with a 19.5" diameter. Place this ring on the

outside of the sphere. By bringing the plane of the ring in parallel with the dark side (night) of the earth, you will outline the section of the sky visible at midnight at the equator during the desired season.

To find particular stars in nature, you can take along the northern sphere of your Baader Planetarium for comparison. Check to see which section of the sphere matches the particular season in question and adjust it accordingly. If you imagine projecting lines from one constellation to another inside the sphere, you will be able to simulate that process when searching for the desired stars in the night sky.

GALACTIC MOTION

Take the whole sphere into your hands by grasping it at the poles to prevent the planetarium from popping open. Then demonstrate the fact that while all these movements of our solar system are taking place in space, **our sun and all its planets are similarly moving around the galactic equator**. This revolution is completed in about every 200 million years. With the sphere held up, we can describe a large circle, indicating this 200 million year orbit. In addition, turning the sphere to face the observer horizontally with its North Pole, we are pointing out that the **position of our solar system in space** is a relative one. It would be a mistake to think that our solar system is positioned horizontally in space. That position depends only on the reference point used by the observer. Were a spaceship located on a solar orbit at a point near the polestar, the astronauts would observe our solar system, seeing the earth coming up on one side of the sun and descending on the other. From that same „location“, the **relativity of the moon's motion** could be clearly observed. The moon describes a weak elliptic orbit around the earth. **That same orbit seen in relation to the sun has a totally different nature when compared to the sun**. An effort should be made to show this phenomenon to the observer. **Looking at the moon in its relation to the sun more closely, we see that it describes an orbit which heads directly for the sun**, then seems to stop for a time, only to move away from the sun and to then overtake the earth, in its own orbit around the sun.

Another amazing Demonstration with the Baader Planetarium calls for the selection of a particular reference point. Previously it was mentioned that we are to look down into the solar system of our planetarium from the north, seeing all motion in space in a counterclockwise direction. The observer must only imagine himself onto the northern hemisphere of the model earth, and from there he must look upward toward the sun. It will become obvious how the sun rises in the east, is positioned in the south at noon and goes down in the west. Having observed the latter principle, we go on with a further Demonstration **Turning the whole sphere** upside down (the sun-earth support should now face upward), **causing the South Pole to be an top**, the observer will be amazed to see that all motion is reversed that now being a clockwise direction. Repeating both demonstrations once watching from the North Pole and then from the South Pole - we note that **the direction of all orbital motion changes at the equator**. Again the Baader Planetarium has managed to duplicate the process found in nature. That phenomena can be observed on any extended air or sea trip across the equator. For in the southern hemisphere the noon sun is seen in the north and moves in an opposite direction much to the confusion of visiting Europeans or North Americans. The observer only needs to imagine himself onto the southern hemisphere of the model earth, seeing why the sun moves in a counterclockwise direction across the sky and appears in the north at midday.

PROJECTING THE STARS

Before turning to the projection part of the Demonstration, it is interesting to show the unique design of the plastic sphere. Two people looking into the sphere from opposite sides can observe the interior, but **will not be able to see each other through the sphere**. Demonstrate this by looking into the planetarium from one side, and have the observer look into the sphere from the side opposite. The reason for this trait is that the plastic used to manufacture the sphere absorbs about 98% of all light, being translucent to only the remaining 2%. Consequently, when we look into the sphere in a darkened room, we receive only 2% of the visible light, with absorption and reflection causing the opposite inside surface of the sphere to appear as an arched and black sky.

To project the stars, constellations and the graduations of right ascension and declination onto the ceiling or dome if available, remove the white sun cover from its fastening. The small lamp will now project opaque sections and lines onto the ceiling in the form of shadows.

Stars, constellation diagrams, and the graduations will appear as precise, dark shapes. In addition, the earth and moon move across this projected firmament, which can be enriched with the cut out constellation figures. You can easily apply the cut outs with tiny pieces of transparent tape.

The room used for demonstrations and for projecting the various constellations onto the ceiling must be nearly dark. As long as there is too much light present, projection of the many constellations will be hindered and appear to have lower quality. It is when you use your Baader Planetarium, in a darkened room with a proper setting, that you will fully enjoy the unit's amazing qualities.



Northern constellations are better suited for projection than their southern counterparts due to the construction of your planetarium. The applied foils will also be an additional aid in recognizing certain constellations when looking into the sphere. Should you desire to project the stars as bright, white spots, you have the additional option to CAREFULLY drill small holes into the sphere at the location of each major star.

It is helpful to use a pencil or pointer to indicate the individual stars as the pointer will also be projected onto the ceiling. In addition, the **foil diagrams** previously cut out, are placed on the globe, **projecting their image onto the ceiling**. As an example, the Big Bear may be projected by placing this constellation near the top of the sphere, thereby reducing any distortion in projection.

In carrying out the above demonstration, it should be made clear that we are in the position to project onto the ceiling the night sky for every day of the year. Look into the globe to where the **ecliptic**-meaning the orbit described by the earth around the sun-becomes visible as a **line depicting the months**. You can now read off a desired month, such as the current one, and then **move the small model earth to that printed month's name by the remote control**, stopping the earth at that point. If the polestar of the sphere is now aligned with the polestar in the sky, and the sphere is turned on its north-south axis by hand until the model earth reaches the highest point in its orbit (consequently the month meridian intersects the highest point of the sphere), then we may instruct the observer that he is seeing the night sky as it would appear on the 15th day of the selected month at midnight. Further, the night sky previous to, or after midnight, may be observed by turning the sphere forward or backward on its north-south axis, adjusting it to the desired hour graduations.

To enrich this particular demonstration, reference can be made to the circumpolar stars, such that the Big Dipper „moves around“ the polestar during the course of one year. In trying to explain the phenomenon of a „moving of the circumpolar stars“, it must be mentioned that the night side of the earth faces different sections of the sky during one revolution around the sun necessarily resulting in the Big Dipper to change its relation to the polestar. **Note that** these relationships can be **visually mastered with the Baader Planetarium**. By stopping the model earth at a particular time of the year, the observer is asked to look from this position at the location of the circumpolar stars, checking out the above relationships.

When demonstrating the projection qualities of the Baader Planetarium, the question may be raised as to the distortion when a spherical, arched ceiling is not available. Mention should be made at this point, that the projection is only an additional advantage, since the main purpose of the Baader Planetarium is to explain celestial relationships and demonstrate the mechanics of the heavens. It should be added, however, that the projection possible is quite impressive and is a thing of beauty. The projection demonstration will be most advantageously shown when the demonstrator limits himself to projecting single constellations or star configurations in a rectangular room. While the individual star projection may be enhanced by drilling small holes into the sphere, a word must be added to the resulting drawbacks. The fine light rays emitted by the drilled holes tend to disturb the observer, which should be considered before carrying on the drilling operation.

STARS OF SUMMER

The ancients, perhaps as much as 7000 years ago, named groups of the brighter stars for the heroes, birds, animals, and divinities of their legends and myths. In this way they commemorated the memories of many important figures just as today ships, buildings, towns, and geographic features are named for outstanding poets, athletes, military men, scholars, or other great men. These areas of the sky came to be known as constellations, and most of them have names of Greek origin. Most of the bright individual stars were later named by the ancient Arabs.

It is often difficult to fit the mythological figures for which the constellations were named to the patterns of stars. But it is easy to imagine geometrical figures such as triangles, squares, crosses, and curved or straight lines connecting the stars, and in this way to remember the locations of the constellations and stars.

Modern astronomers use the constellations for locating objects in the sky, just as state boundaries are used in the United States. When it is said that a certain star is in a particular constellation the approximate position of the star is indicated.

Most people overestimate the number of stars they see in the sky at any one time, and guess that tens of thousands are visible. However, even with the best conditions, only approximately two thousand in about thirty constellations can be seen at a particular time.

Different constellations are visible during different seasons because of the earth's motion around the sun. During December and January the sun is in the direction of the stars in Sagittarius, and in nearly the opposite direction the constellation of Orion is visible in the night sky. Six months later, after the earth has revolved half of the way around its orbit the sun will be among the stars of Orion, and the stars in Sagittarius are now opposite to the sun and can be seen after sunset.

The stars in the northernmost part of the sky are visible at some time of night all through the year. Some of these stars and constellations can be used as guideposts to find others.

The constellation of Ursa Major, the Great Bear, is now in the northern-western sky. It is the most conspicuous group of stars in the north at any time of the year. The brightest stars in the constellation outline an imaginary Big Dipper. Alcor and the much brighter Mizar, are two very close stars at the bend of the Dipper's handle. Dubhe and Merak, the two stars in the outer end of the bowl of the Dipper are called the Pointers. They were named the Pointers because if a line is imagined to join them, and then extended about five times the distance between the stars it terminates near the North Star, or Polaris.

Polaris is at the end of the handle of the Little Dipper. The Little Dipper is a part of the constellation of Ursa Minor, the Little Bear. Kochab is the star at the outer open end of the Little Dipper's bowl. The other stars in Ursa Minor are quite faint and visible only when the atmosphere is very clear.

Another imaginary line extended from the middle of the Big Dipper through the North Star and beyond, soon passes through a group of five stars forming the letter W. These are the brightest stars in Cassiopeia, the constellation named for a queen of ancient Ethiopia.

The constellation of Cepheus, the king and husband of the queen of Ethiopia, is found between Cassiopeia and Draco. The pentagon in Cepheus is the brightest pattern of stars in the constellation, and they do not look very bright.

Draco, the Dragon, contains a long twisting line of faint stars which meanders between the Bears. Draco extends from below and to the west of Ursa Minor upwards until its diamond-shaped head is almost at the point overhead. The star Thuban, in Draco, was the North Star about 5000 years ago. It is the third star from the end of the Dragon's tail, and about half way between Mizar and the bowl of the Little Dipper. Directly below Cassiopeia, and very close to the horizon, are the stars in the constellation of Perseus, the Hero. Perseus slew Medusa, a horrible creature called a Gorgon, and afterwards rescued the maiden Andromeda, the daughter of Cassiopeia and Cepheus from Cetus, the Sea Monster. Cetus is a region of the sky containing only faint stars, and which is not visible at this time. Perseus contains an interesting star named Algol which changes in brightness. If the curve of the handle of the Big Dipper is extended away from Polaris and the open end of the bowl it passes close to two very bright stars in the western sky. The brightest and highest of the two stars is Arcturus. Arcturus is orange in color and the brightest star in the constellation of

Bootes, the Herdsman. Bootes is also known as the Bear Driver because he seems to be pursuing Ursa Major around the North Star as the earth rotates.

Spica, the second bright star, is farther to the west and very close to the horizon. Spica is the brightest star in Virgo, the Virgin. Some of the stars in Virgo form a very long irregularly shaped rectangle. One legend identifies Virgo with the ancient Greek goddess of justice.

Just to the south of Bootes is Corona Borealis, the Northern Crown. Its brightest stars form a semi-circle. Gemma, the Crown Jewel, and the brightest star in the pattern is near the central position in the circlet.

Higher in the sky and to the south of Corona Borealis, and extending to almost the point directly overhead is the constellation of Hercules. Though this constellation covers a great area of the sky, it has only faint stars in it.

The constellation of Scorpius, the Scorpion is close to the horizon, and slightly to the west of south during the early summer evening. Antares, the brightest star in the body of the Scorpion is reddish in color. Three stars to the west of Antares mark the Scorpion's head and claws, while a long curved row of stars extending down and to the east forms its tail. Faint stars quite near each other mark the sting at the end of the tail.

Above Scorpius are two constellations that cover a large area of the sky. Ophiuchus, the Serpent Holder, grasps Serpens, the Serpent (which curves upward to both the east and west from the most southerly portion of Ophiuchus) in his hands. Neither constellation contains any bright stars.

Libra, the Scales or Beam Balance, another zodiacal constellation, can barely be seen in the southwest for it contains no very, bright stars. Libra is the only constellation in the zodiac which is not ariimate.

Sagittarius, the Archer, is half man and half horse, a mythological being called a Centaur. Since the pattern of brightest stars in this zodiacal constellation forms a teapot it is easy to find.

Close to the southeastern horizon is the constellation of Capricornus, the Sea Goat. The tenth constellation of the zodiac, Capricornus' brightest stars form two wide V's which meet at their open ends. This constellation was the origin of the Tropic of Capricorn around the earth because long ago the sun's southernmost point in the sky was in it.

Between Capricornus and Pisces lies another zodiacal constellation, Aquarius, the Water Bearer. The long crooked line of faint stars represents an old man pouring water from a jar and into the mouth of Pisces Austrinus, the Southern Fish, barely on the southern horizon.

Higher in the sky and between Capricornus and Sagittarius is the constellation of Aquila, the Eagle. The brightest star in the constellation is Altair.

Sagitta, the Arrow, is formed by three faint stars in a nearly straight horizontal line slightly north of Altair.

To the east of Aquila is the small constellation of Delphinus, the Dolphin. Delphinus contains four faint stars which form a small diamond with a tail pointing southward.

Nearly overhead is the small constellation of Lyra which contains bluish Vega, the brightest star in the summer sky. Only a few nearby faint stars are also easily visible. This grouping of stars represents the lyre of Orpheus, the famous musician of Greek mythology. His music was so wonderful that the gods of old placed his instrument in the sky.

Just to the north of Pisces, the Fishes, which is rising at this time, is the Great Square of Pegasus. Three of the stars in the Square, with others to the south form the upside down imaginary figure of the Winged Horse. The star Alpheratz, which marks the northwest corner of the Great Square, and the other stars to the north of about the same brightness are in the constellation of Andromeda. Andromeda does not contain any bright stars.

A line from the Big Dipper's bowl and passing through Polaris leads to Deneb, the brightest star in Cygnus, the Swan. Between Pegasus and Lyra, the pattern of bright stars in Cygnus forms the Northern Cross. Deneb is the star at the northernmost end of the Cross upright, and the one at the southern end, or foot of the cross is Albireo. Deneb can also be imagined to mark the tail of a flying swan, and Albireo the head.

The famous Summer Triangle is formed by connecting Vega, Altair, and Deneb with imaginary lines. This triangle of bright stars is known as the sign of the summer skies.

During the summer the hazy band of the Milky Way can be traced through the tail of Scorpius, Sagittarius, Aquila, Cygnus, Cepheus, Cas- siopeia, and Perseus. It appears both widest and brightest in Sagittarius.

As the night passes other constellations rise. Pisces becomes more easily visible, followed by Aries, the Ram, and Cetus then the approaching sunrise illuminates the sky and the stars disappear.

STARS OF WINTER

The northern circumpolar constellations and stars are described in the „Stars of Summer“. This portion of the presentation on the summer skies can also be used in this demonstration.

The ancients divided the sky into areas, which now after many revisions and additions total 88 constellations. About 60 of the constellations can be seen through a year's time from midnorthern latitudes. These portions of the sky have standardized imaginary boundaries which help to locate celestial objects., just as state boundaries in the United States can be used to give the approximate locations of cities.

Astronomers use the Greek alphabet in one system of designating bright stars. The brightest star in a constellation is given the first letter of the alphabet, Alpha. The second brightest star is then designated Beta, the third is assigned Gamma, and the procedure is continued through out the constellation and alphabet. (There are but a few exceptions in this system.) In this method the name of the constellation in which the star is found takes the Latin genitive, or possessive form.

Usually about 15 of the 20 brightest stars visible from midnorthern latitudes can be seen in the winter sky. During most winter evenings 10 of the 15 brightest stars are above the horizon at some time.

Above the eastern horizon is the bright blue-white star, Regulus, or Alpha Leonis at the end of the handle of the sickle, or backwards question mark in the constellation of Leo, the Lion. (Regulus also very closely marks the position of the sun on August 20.) Regulus can be imagined to represent the Lion's heart, while the curve of the sickle outlines his head and mane.

The Lion's hind quarters and tail are to the northeast, and defined by a right triangle of stars. The lowest star in the triangle marks the tip of the Lion's tail, and is called Denebola, from the Arabic for the Lion's tail. Denebola is also Beta Leonis.

The constellation of Cancer, the Crab, lies between the constellations of Leo and Gemini. It contains only a few apparently very faint stars and M44, a faint hazy patch of light. M44 is actually a distant cluster of thousands of stars called the „Beehive“, or Praesepe.

Above Cancer are two bright stars, Castor and Pollux. The two stars are close together, and mark the heads of Gemini, the Twins, another zodiacal constellation. The bodies of the twins extend southward from these stars and are outlined by stars which form a long rough rectangle.

To the south of Cancer is the small constellation of Canis Minor, the Smaller Dog, which has only one bright star in it named Procyon.

Farther south and across the band of the Milky Way, now arching across the sky from the southeast to the northwest, is one of the largest and most conspicuous of the winter constellations, Orion. Four bright stars mark the shoulders and feet of Orion, the Mighty Hunter. If these stars are connected by lines they form a slightly distorted rectangle. Betel- geuse, or Alpha Orionis, is reddish in color and indicates Orion's right shoulder while bluish-white Rigel, or Beta Orionis, marks his left foot. Below and to the west of Betelgeuse three almost equally bright close stars in a straight row form Orion's belt. A faint star and a patch of light, M42, in a nearly vertical line below the stars in the belt mark Orion's sword. A faint star above and between the two bright stars representing Orion's shoulders marks his head. Orion is imagined to be facing the earth with his head turned toward his left. His right arm is raised, and he has a great club in his hand (within the outlines of the Milky Way). His left arm extends toward the west with a shield of lion's skin.

Orion contains seven apparently very bright stars. One of them, Rigel, is the seventh brightest star in the sky. In true brightness it is second only to Canopus in the southern sky. It gives off approximately 14,000 times as much light as the sun, but Rigel appears to be much fainter because it is about 460 light years distant. The three stars in Orion's belt, Mintaka, Alnilam, and Alnitak (from east to west) are all second magnitude stars. (The northernmost and most western one, Mintaka, is almost exactly on the celestial equator.)

The red star Betelgeuse is the third largest star known. It changes in diameter from 300 to 480 times that of the sun. Its largest volume is nearly 30,000,000 times that of the sun, however, its mass is only 50 times the sun's, therefore its density is very low. It is approximately 240 light years from the sun.

A line through Orion's belt pointing downward to the southeast passes close to Sirius, the brightest star in the sky. Sirius is in the constellation of Canis Major, the Larger Dog.

Orion's sword points southward toward a small constellation containing only a few faint stars. Lepus, the Hare, is one of the most southerly constellations that can be observed from mid-northern latitudes, and is only easily visible on dark, clear nights.

Higher in the sky and to the west of Orion is Taurus, the Bull. The Bull appears to be charging Orion, who is in a position to defend himself. The Bull's eye is marked by the bright red star Aldebaran, or Alpha Tauri. A group of stars called the Hyades forms the V-shaped face of the Bull. They are members of a cluster of stars traveling together through space. The extremely long horns of the Bull extend eastward and to the north until they end with their points over Orion.

Another cluster of stars called the Pleiades, or the Seven Sisters, is in the shoulder of the Bull. Only about six of these stars are visible to a person with average vision.

To the south of Taurus, Eridanus, the River, is so long that it can be divided into northern and southern streams. The northern stream winds from near Rigel in Orion to the feet of Cetus, in the west. The southern stream is not visible from middle northern latitudes because it is too far south. Except for the star Achernar (which is below the horizon), the constellation has no bright star although it is the longest constellation in the sky.

Above the north star and almost directly overhead is the bright star Capella, the brightest star in Auriga, the Charioteer. The name Capella means the she-goat, and three very faint stars near it are called the Kids.

The circumpolar constellations, Cassiopeia and Cepheus, the Queen and King of Ethiopia, in the northern sky are two of half a dozen constellations named after the main characters in one of the old myths. The heroine of this story is Andromeda, the daughter of Cassiopeia and Cepheus. Three of the remaining four of these constellations are to the west and southwest. Perseus, the Hero of the legend is nearly overhead and to the west of Auriga.

In Perseus, high in the western sky, is the star Algol, the Demon. This name may have been given to the star by the Arabs who noticed that it changes in brightness.

In the northwest Andromeda contains a nearly vertical row of stars, the lowest of which is the upper corner of a large square that is nearly setting. The other three stars in the square are in the constellation of Pegasus, therefore, the square is called the Square of Pegasus.

To the south of the square and above it are the faint stars in Pisces, the Fishes. Pisces is almost setting due west at this time.

Then more southerly, but higher in the sky is Aries, the Ram. And yet farther to the south is Cetus, the Sea Monster, with the bright star Mira.

As the night passes the constellation of Virgo, with its bright star Spica, Bootes with the bright star Arcturus, Corona Borealis, and Hercules rise.

With the dawn Gemini is setting in the west, and Lyra and Cygnus are rising in the northeast.

CONSTELLATIONS

Identified here are the constellations enclosed with your BAADER PLANETARIUM. Carefully cut out the individual figures on their transparent border. The constellations may then be fastened to the celestial globe with transparent tape.



1. Aql - AQUILA - Eagle; 2. PsA - PISCIS AUSTRINUS - Southern fish; 3. Sge - SAGITTA - Arrow; 4. Leo - LEO - Lion; 5. Cam - CAMELOPARDUS - Giraffe; 6. Crv - CORVUS - Crow; 7. Lyn - LYNX - Lynx; 8. Ari - ARIES - Ram; 9. Her - HERCULES - Hercules; 10. Ara - ARA - Altar; 11. Gem - GEMINI - twins; 12. Lac - LACERTA - Lizard; 13. Col - COLUMBA - Dove; 14. Hyi - HYDRUS - Water serpent; 15. Oph - OPHIUCHUS - Aesculapius grappling the serpent.

16. Sct - SCUTUM - Shield; 17. Tri - TRIANGULUM - Triangle; 18. Lep - LEPUS - Hare; 19. Sgr - SAGITTARIUS - Archer; 20. CVn - CANES VENATICI - Hunting Dogs; 21. Com - COMA BERENICES - Berenice's hair; 22. Mon - MONOCEROS - Unicorn; 23. Del - DELPHINUS - Dolphin; 24. TrA - TRIANGULUM AUSTRALE - Southern triangle; 25. UMa - URSA MAJOR - Big bear; 26. Lib - LIBRA - Balance scales; 27. Cas - CASSIOPEIA - Queen of Ethiopia.



28. Cet - CETUS - Whale; 29. Cyg - CYGNUS - Swan; 30. UMi - URSA MINOR - Little bear; 31. Per - PERSEUS - Savior of Andromeda; 32. Psc - PISCES - Fishes; 33. CrB - CORONA SOREALIS - Northern crown,- 34. Cep - CEPHUS - King of Ethiopia; 35. Gru - GRUS - Crane; 36. Cap - CAPRICORNUS - Sea goat; 37. And - ANDROMEDA - Princess of Ethiopia; 38. Lyr - LYRA - Harp; 39. Cnc - CANCER - Crab; 40. Lup - LUPUS - Wolf; 41. Sco - SCORPIUS - Scorpion; 42. Ori - ORION - Hunter; 43. Peg - PEGASUS - Winged horse; 44. Aur - AURIGA - Charioteer; 45. CMi - CANIS MINOR - Little dog; 46. CrT - CRATER - Cup; 47. Eri - ERIDANUS - Po River; 48. Cru - CRUX - Cross (Southern); 49. Vir - VIRGO - Maiden; 50. Hya - HYDRUS - Water serpent.

51. Cen - CENTAURUS - Centaur; 52. Boo - BOOTES - Herdsman; 53. Dra - DRACO - Dragon; 54. Phe - PHOENIX - Periodically resurrecting bird; 55. Tau - TAURUS - Bull; 56. Pav - PAVO - Peacock; 57. LMi - LEO MINOR - Little Lion; 58. Aqr - AQUARIUS - Water bearer; 59. CMa - CANIS MAJOR - Big dog; 60. Car - CARINA - Ship's keel; Dor - DORADO - Swordfish; Pup - PUPPIS - Stern of the Argonauts' Ship; Pyx - PYXIS - Mariner's compass; Vel - VELA - Sail.

PLATONIC YEAR

Lastly, a demonstration of the **Platonic year** is made possible with the Baader Planetarium. The observer should be told that the sun has an influence on the position of the earth's axis (straightening its angular tilt), by its **gravitational forces**. The earth in turn has a precession of the equinoxes, with that complete revolution having a cycle of 25,800 years, and being known as the Platonic or great year. In that process, the earth counters the gravitational influence of the sun (lunisolar precession) by carrying out a precession motion (clockwise from the north) against the direction of its rotation (counterclockwise from the north). By carefully grasping the lower sun-earth support, and rotating it once in a clockwise direction, we are thereby demonstrating a **complete precession cycle of 25,800 years**. In that latter demonstration, the line depicting the months would equal a time span of 2,150 years for each monthly division.

By turning the inside support in such a manner, we see how the **ancient Greeks observed a different starry sky during a particular season when compared to our time**. With the Baader Planetarium you can therefore show how the heavens appeared during Roman times, for example, such as at the birth of Christ. This demonstration was previously possible only with full sized planetariums. A comment should be made, that spring on earth does not start when the earth is on the „spring side“ of the sun, that being under the sign of the Fishes. Historical reasons put the **beginning of spring at the vernal equinox**, or the point where the sun's center crosses the spring point. This same Tradition is responsible for such astronomical terminology as „**the sun passes along the ecliptic**“. The Baader Planetarium will again point out the natural occurrence of events, showing that the earth revolves around the sun in one year **leading to the belief that the sun has made a similar motion on the ecliptic**.

The precession motion of the earth is connected with the fact that the sun would have to be under the sign of the Ram on March 21st, according to general custom. The Greeks, who called the sign of the zodiac into being, actually found that the March 21st date applies. Due to the precession and the gyrating, top like effect of the earth's axis, we now **see the sun at the onset of spring between the signs of the Water Bearer and the Fishes**. This latter effect is called the „**movement of the spring point (equinoxes)**“.

ADDITIONAL CONCEPTS

For example, we may say that the orbit of a man made satellite remains constant in space, once it has reached the target trajectory path. The model polar satellite orbit in the Baader Planetarium permits the earth to rotate under that orbit, enabling the satellite to observe or „photograph“ the entire earth several times. With binoculars we are in a position to watch and explain the light phases of Venus, giving insight into why we see Venus sometimes as a morning, and at other times as an evening star. The nature of the Mars orbit enables us to observe the northern, or at other times the southern pole of Mars, and explains why each of these poles in turn becomes more easily visible to the human observer equipped with a telescope. In addition, the movements of the planetarium's moon will explain why we see 6% more than one-half of the moon's surface. That phenomenon is due to the inclination of the moon's orbit in regard to the orbital path of the earth. "We sometimes see the moon more from the top and at other times more from the bottom." When demonstrating the projection features of the planetarium, we can point out the difficulties of map projection, since we are projecting a grid onto a flat surface. In addition, we should mention that the adjusting of the sphere to the polestar in the sky gives the observer a great deal of insight into the natural relationships. The observer can now apply and compare reality with the model.

Should it prove that our demonstrations have enriched the imagination and the understanding of the observers participating, we can be pleased in having brought these individuals a step closer to meeting the demands of our space age society.

With the above instructions for a stimulating demonstration, the Baader Planetarium will be appreciated for its uniqueness and its multitude of uses. In conclusion, it may be stressed that all these features of the Baader Planetarium will not be found elsewhere - with registered patents assuring the continuing success and superiority of this amazing planetarium.

DOMESTIC AND FOREIGN PATENTS PENDING. - WE RESERVE THE RIGHTS FOR ALL FILMING OF TELEVISION BROADCASTING.

The terms synodic and sidereal time have been previously explained. At first, one is amazed to see these phenomena occurring inside the BAADER PLANETARIUM. However, after some observation, the reasons

become obvious. In addition, you will witness the formation of the sidereal and synodic months. Count the sidereal month against a star (close to 4 orbits); the synodic month is measured against the sun (close to 3 orbits) and the draconitic month by counting the times the moon's shadow crosses the line depicting the months on the sphere's inside.

Time required for the planets to orbit the sun: (order of planets as seen from the sun)

1.	Mercury	88 days
2.	Venus	225 days
3.	Earth	365 1/4 days
4.	Mars	687 days
5.	Jupiter	11 years 315 days
6.	Saturn	29 years 167 days
7.	Uranus	84 years 5 days
8.	Neptune	164 years 289 days
9.	Pluto	248 years 315 days

Halley's comet requires 76 1/3 years to orbit the sun.