

StarSense™ Autoguider

INSTRUCTION MANUAL

ENGLISH

Model # 94008

See product page at celestron.com for other language versions of this instruction manual.
 Consultez la page produit sur celestron.com pour les autres versions linguistiques de ce manuel d'instructions.
 Siehe die Produktseite auf celestron.com für andere Sprachversionen dieser Bedienungsanleitung.
 Consultare la pagina relativa al prodotto su celestron.com per le versioni in altre lingue del presente manuale di istruzioni.
 Consulte la página del producto en celestron.com para ver las versiones en otros idiomas de este Manual de instrucciones.

With the Celestron StarSense Autoguider, using a Celestron telescope for astromaging has never been easier. This all-in-one accessory can help with every aspect of telescope alignment and tracking. With your new StarSense Autoguider (SSAG), you can:

- Automatically align your equatorial or altazimuth telescope to the night sky in just a few minutes. Once aligned, your telescope will find and center objects with enhanced pointing accuracy.
- Guide your telescope accurately during long astromaging exposures without any additional alignment required (not even polar alignment).
- Quickly and accurately polar align your equatorial mount, if desired.

Please read this manual before setting up and using your StarSense Autoguider. You can find the most current version of this instruction manual on the StarSense Autoguider product page at celestron.com.

⚠ WARNING – Never point the StarSense Autoguider at the Sun! Doing so will damage SSAG's image sensor. This damage is not covered under your warranty. Keep SSAG's cover cap on during the day.

TABLE OF CONTENTS

1. Parts List	1
2. Installation	1
3. Controlling your StarSense Autoguider	3
4. Using SSAG with NexStar+ Hand Control	3
5. Using SSAGE with CPWI	7
6. Focusing	10
7. Status LED Ring	10
8. Using Filters	10
9. Updating SSAG's Internal Software with CFM	10
10. Updaing SSAG's Internal Software and Live View via Web Interface	11
11. Troubleshooting and Tips	11
12. Specifications	11

1. Parts List

- A. StarSense Autoguider with cover cap
- B. Large bracket (pre-installed on StarSense Autoguider)
- C. Large bracket base
- D. AUX cable
- E. Phillips head screws (2)
- F. Large bracket base thumbscrews (2)
- G. Hex key
- H. Small bracket



2. Installation

StarSense Autoguider connects to your optical tube using one of the two supplied brackets (i.e., the large bracket or the small bracket). Use the large bracket with Schmidt-Cassegrain, EdgeHD, and RASA telescopes with 5" or more of aperture (Fig. 2).



Use the small bracket with other telescopes that have a standard dovetail base for a finderscope (Fig. 3).



If you are using a telescope smaller than 5" in aperture, and your telescope does not have a standard dovetail base you must purchase a standard dovetail base from a third-party supplier.

If you are using the pre-installed large bracket to mount SSAG to your telescope tube:

1. Connect the large bracket base to the telescope. (Note: Some telescopes may already have this base installed; it is the same one used for the 8x50 finderscope included with several telescopes.) If you need to install the base, use the Phillips-head accessory screws, which are pre-installed in the rear cell of the telescope. There are usually two locations on the rear cell to mount the base (Fig. 4).



Fig. 4: The large bracket can be connected to the OTA in two locations on most Celestron telescopes.

2. Remove the screws, orient the base as shown, and line up the holes in the base with the holes in the rear cell.
3. Reinstall the screws so the base is secure. If needed, use the two supplied Phillips head screws.
4. Loosely thread the two thumbscrews into the large bracket (Fig. 5).



Fig. 5: Install the thumbscrews into the large bracket base. These secure the large bracket.

5. Slide the bracket onto the base until it is fully seated.
6. Tighten the thumbscrews to secure the bracket to the base.

The optional 8" CGE Dovetail Bar for mounting accessories will obstruct SSAG's large bracket. The CPC 800 fork arm also obstructs SSAG. For these configurations, attach the base and large bracket backwards as shown in Fig. 5a.



Fig. 5a: You'll need to install the base and large bracket backwards on a CPC 800 telescope.

If you are using the small bracket, you'll need to remove SSAG from the large bracket first. To mount SSAG with the small bracket:

1. Unthread SSAG's front housing completely and remove it. Doing this will expose SSAG's optical tube (Fig. 6). Also, remove the orange front cosmetic ring.

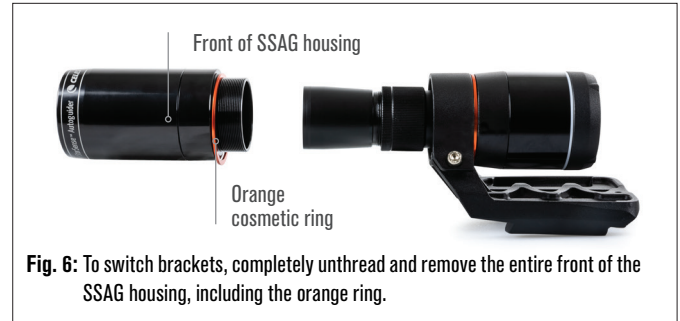

Fig. 6: To switch brackets, completely unthread and remove the entire front of the SSAG housing, including the orange ring.

NOTE: When removing the front housing to install the small bracket, you could accidentally affect SSAG's factory focus. Keep this in mind when you are using SSAG later. If the device is not working correctly and you are receiving "No Stars!" error messages, you may need to refocus. To do so, refer to the section on Focusing later in this manual.

2. Use the hex key to loosen the socket head cap screw, which provides the bracket's clamping force. Then pull SSAG out of the bracket (Fig. 7). Doing this will also remove the orange rear cosmetic ring.



Fig. 7: Loosen the socket head cap screw. Remove SSAG from the large bracket, including the rear orange ring.

3. Loosen the socket head cap screw on the small bracket's clamp and install SSAG and the orange ring into the small bracket. Orient it as shown (Fig. 8).

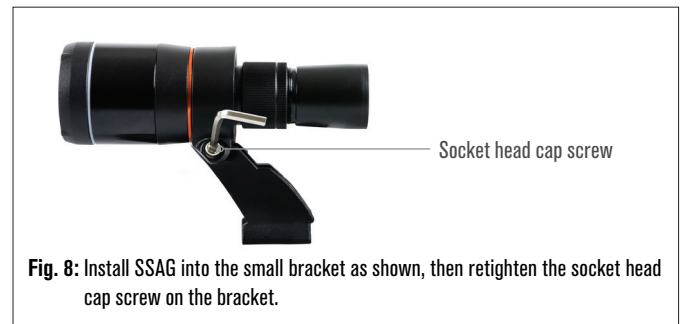

Fig. 8: Install SSAG into the small bracket as shown, then retighten the socket head cap screw on the bracket.

4. Retighten the socket head cap screw on the small bracket's clamp.
5. Reinstall SSAG's front housing and the orange front ring (Fig. 9).



Fig. 9: Reinstall the front housing onto SSAG. Don't forget the orange cosmetic ring!

6. To install SSAG into your telescope's standard finderscope dovetail base, simply insert the small bracket into the base and tighten the thumbscrew on the base to secure it in place.

Now that you have installed SSAG, you'll need to connect its AUX port to one of the AUX ports on your telescope mount. Use the supplied AUX cable (Fig. 10). If you do not have an available AUX port on your mount, consider purchasing an optional Celestron AUX Port Splitter.



Fig. 10: Use the supplied AUX cable to connect SSAG's AUX port to the mount's AUX port.

3. Controlling Your StarSense Autoguider

There are several ways to control your StarSense Autoguider:

NexStar+ Hand Control

To use SSAG with the NexStar+ hand control that came with your Celestron mount, you will likely need to update the hand control's firmware. You'll need firmware version 5.35.XXXX or greater. To check your firmware version number, press the MENU button. Use the SCROLL and ENTER buttons to navigate to Hand Control>Get Version Info. Use the Celestron Firmware Manager (CFM) software to update the firmware if needed. You'll find the latest version of CFM here: celestron.com/pages/drivers-and-software

You'll need a USB cable (Type-A to Mini-B) to connect the hand control to your PC. Refer to section 9 of this manual (page 10) for more information.

CPWI Telescope Control Software for PC

You can control your telescope and StarSense Autoguider with our free Celestron CPWI software. To download the latest version, visit: celestron.com/pages/celestronpwi-telescope-control-software

You'll need CPWI version 2.5.0 or greater. Install the software and open CPWI. Select "Start" if the opening window appears. Then, click on the "Connection" icon in the upper left corner of the screen. If you are using a wired connection to your Celestron mount (i.e., through the hand control or the mount itself), select "USB." If you are using the SkyPortal WiFi Module, select "WiFi." CPWI should find and connect to the autoguider. Once connected, the SSAG icon will appear in the selection menu on the left side of the screen. Select the icon to display the StarSense Autoguider menu (Fig. 11).

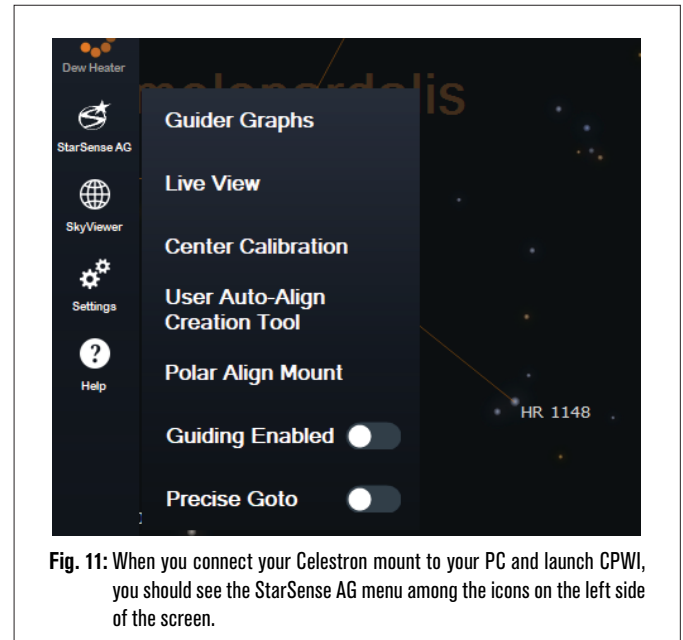

Fig. 11: When you connect your Celestron mount to your PC and launch CPWI, you should see the StarSense AG menu among the icons on the left side of the screen.

SkyPortal App for iOS and Android

If you use the Celestron SkyPortal WiFi Module or have a Celestron mount with built-in WiFi (e.g., NexStar Evolution), you can use the SkyPortal app to control your SSAG. Please refer to the Support & Downloads section on the StarSense Autoguider page at celestron.com for more information.

4. Using SSAG with the NexStar+ Hand Control

The NexStar+ hand control is perhaps the simplest way to control your SSAG, as it doesn't require an external computer. You can use the hand control as you normally would but with SSAG's enhanced functionality.

Auto Align

One of SSAG's most convenient features is its ability to align your Celestron mount to the night sky automatically. No more manually centering stars to provide alignment references; it's all handled automatically.

To perform an automatic alignment using the NexStar+ hand control:

1. Power on the mount.
2. Press ENTER.
- 3 a. **If you have an EQ mount with home position switches**, such as the CGX or CGX-L, the hand control will prompt you to move the mount to its home position. Press ENTER.

- b. If you have an EQ mount without home positioning switches**, such as the Advanced VX mount, the hand control will prompt you to manually move the mount to its index marks. To do this, loosen the clutches and rotate the RA and DEC axes until the index marks line up. Then retighten the clutches and press ENTER.
- c. If you have an AZ mount**, point the telescope toward the northern horizon (i.e. tube positioned horizontally and pointing roughly North) or southern horizon if you are located in the Southern Hemisphere. Then, use the SCROLL UP and SCROLL DOWN keys to select "Auto Align." Press ENTER.
4. If you are using an EQ mount, you will now be asked if you would like to polar align the mount. We recommend polar aligning before doing sky alignment, as you will need to perform sky alignment again if you polar align later. If you would like to polar align at this time, press the ALIGN button. Otherwise, press ENTER to continue with sky alignment. If you have chosen to polar align now, refer to the Polar Alignment section on page 5.
5. Follow the onscreen prompts to input your location, local time, and date.
- You may want to use the city database to set your location. Don't worry if your exact location is not in the database. Just select the nearest city.
6. Select an alignment method. (If you are using an AZ mount, you did this in Step 3c.) Use the SCROLL UP and SCROLL DOWN keys to select "Auto Align." Press ENTER.
7. The mount will begin slewing to a position where SSAG will obtain its first alignment reference. Once the mount stops slewing, SSAG will capture an image of the sky and determine its position.
- NOTE:** If the telescope automatically slews to point to an area of the sky that is locally obstructed (by buildings, trees, etc.), it will fail and automatically slew to another point to try again.
8. The mount will slew to another position to obtain the second alignment reference.
9. If you are using an altazimuth mount, the Auto Align process is now complete. If you are using an equatorial mount, SSAG will slew to a third position on the other side of the meridian to obtain a third alignment reference.
10. After SSAG has captured two or three references, you will see "Align Success!" on the NexStar+ LCD screen.

Your mount is now aligned. However, before it can accurately place objects in the telescope's field of view, SSAG must determine the offset between its own field of view and that of the telescope in a process called "center calibration." If you have never center-calibrated SSAG and your telescope, the hand control will prompt you to do so immediately after initial alignment. Refer to the "Center Calibration" section later in this manual. If you have performed a center calibration previously, the telescope is now ready to find and place objects near the center of the field of view.

Manual Align

You may consider using the Manual Align option if you have many obstructions at your observing location, such as buildings, trees, or power lines. Manual Align works like Auto Align but allows you to manually slew the telescope to clear areas of the sky to obtain the alignment references. Because the telescope won't automatically slew to positions blocked by obstructions, the overall alignment process is quicker.

To perform a "manual" alignment using the NexStar+ hand control:

1. Follow steps 1 through 5 in the Auto Align section above.
2. When the hand control prompts you to select an alignment method, use the SCROLL UP and SCROLL DOWN keys to select "Manual Align" and press ENTER.
3. The hand control will prompt you to slew the telescope to a clear area of the sky using the direction buttons. When the telescope is pointing

to a clear area of the sky, press ENTER. SSAG will capture an image to use as an alignment reference.

NOTE: For best results with EQ mounts, do not slew the telescope towards the North (or South) poles to capture alignment references.

4. The hand control will prompt you to manually slew the telescope to another clear area of the sky.
 - a. **For altazimuth mounts**, slew the mount in both axes, making sure SSAG is pointing at least 60° away from its first alignment point. Press ENTER. The Manual Align is now complete. Skip to Step 7.
 - b. **For equatorial mounts**, slew the mount to another clear area of the sky. This location must be on the same side of the meridian as the first area you chose. Press ENTER.
5. After completing the first two alignment references, the hand control will display "Add Calib Star?" We strongly recommend adding a third alignment reference for the best overall pointing accuracy across the sky.
 - a. Choose "No" to end the alignment with only two references. This alignment may provide acceptable pointing accuracy in many cases, especially if Precise GoTo is on (as explained later in this manual). Skip to Step 7.
 - b. Choose "Yes" to add a third alignment reference. The telescope will automatically slew to the other side of the meridian.
6. With the telescope now on the opposite side of the meridian from the first two alignment points, the hand control will prompt you to choose a third clear area of sky. Use the direction keys to slew to a clear area of sky on this side of the meridian and press ENTER.
7. You will see "Align Success!" on the NexStar+ LCD screen when completed.

Your mount is now aligned. However, before it can accurately place objects in the telescope's field of view, SSAG must determine the offset between its own field of view and that of the telescope in a process called "center calibration." If you have never center-calibrated SSAG and your telescope, the hand control will prompt you to do so immediately after initial alignment. Refer to the "Center Calibration" section later in this manual. If you have performed a center calibration previously, the telescope is now ready to find and place objects near the center of the field of view.

User Auto Align

This alignment method only works after you have performed at least one Manual Auto Align. When you select User Auto Align, the telescope automatically moves to the alignment points you defined during the previous Manual Auto Align. It's a handy option if you set up in the same location most nights and there are significant obstructions at the site.

To perform a User Auto Align, follow the instructions for Auto Align above but choose "User Auto Align" as the alignment method. Once initiated, the telescope will automatically slew to the first alignment point in the prior Manual Auto Align. It will then proceed to the other user-defined points to complete the alignment.

Last Align

If you leave your telescope set up in a single location, such as a home observatory, Last Align is a convenient choice. You can only use this method if you do not slew or otherwise move the telescope in any way after powering it off. This alignment method uses the previous SSAG alignment data stored in the hand control. No further action is required.

Quick Align

This procedure aligns the mount using only the time/date/location information. It assumes that equatorial mounts are perfectly polar aligned and altazimuth mounts are level and pointing North. Quick Align does not use the SSAG device.

We don't usually recommend this alignment method. But if your mount is already well polar aligned, this option may provide accurate enough pointing and tracking with no further alignment required. It can also be handy when you are searching for planets in twilight.

EQ North Align and EQ South Align (AZ mounts only)

If you are using an AZ mount on an equatorial wedge, choose "EQ North Align" in the Northern Hemisphere or "EQ South Align" in the Southern Hemisphere. Follow the steps for Auto Align described above, but now consider your telescope an EQ mount instead of an AZ mount.

Center Calibration

Center calibration aligns SSAG's field of view with that of your telescope. You'll generally only need to center-calibrate the first time you use SSAG with a new telescope tube. However, you may need to center-calibrate again if you remove the bracket base from the telescope and then reinstall the bracket. If you only remove SSAG and its bracket, leaving the bracket base on the telescope, you should not need to center-calibrate again.

Before doing a center calibration, align the telescope to the night sky using one of the above procedures. If you have not center-calibrated previously, SSAG will automatically initiate a center calibration after sky alignment.

To perform a center calibration:

1. Press the MENU button and use the SCROLL keys to select "SSAG." Press ENTER. Use the SCROLL keys to select "Center Calibrate" and press ENTER.

NOTE: If you have never center-calibrated SSAG, the NexStar+ hand control will automatically start the center calibration process after alignment.

2. Next, use the SCROLL keys to select either Named Stars or Solar System Objects (i.e., planets) to use for center calibration. Press ENTER. Scroll through the list of stars or planets and select one clearly visible from your location. Press ENTER.

- If you are unsure where the object you chose is in the night sky, don't worry. The telescope will point close to the object in the next step. You can use the telescope as a guide to determine which star or planet you are using to center-calibrate. Remember that named stars and planets are among the brightest objects in the night sky.

- For best results with an EQ mount, choose stars that are close to the celestial equator (i.e., away from poles).

3. The telescope will slew to the star or planet you chose. Depending on the offset between SSAG's field of view and the telescope's, the object may or may not be in the telescope's field of view. In any case, the telescope should generally be pointing toward the object.

4. The NexStar+ hand control will ask you to center the object in the field of view of the finderscope. Use the direction buttons on the keypad to do this. Don't worry about fine centering yet—that happens in the next step. For now, roughly center the object in the field of view of the finderscope and press ENTER.

- If the star is not within the finderscope's field of view, slew the telescope manually until it is.
- If you're not using a finderscope, use your widest field eyepiece in the telescope for this step. If the object is not in the field of view, try sighting down the length of the telescope tube to point to the object.

5. The NexStar+ hand control will prompt you to center the object in the eyepiece's field of view. This is the fine-centering step. Make sure there is a high-powered eyepiece in the telescope. Use the direction buttons on the keypad to center the object. For the best results, use the up and right direction keys last. When you finish, press ALIGN.

6. SSAG will perform the center calibration and return the message "Center Calib Success."

Once you've completed Auto Align and Center Calibration, you can command the telescope to accurately place any celestial object you choose within the telescope's field of view.

Autoguiding

If you are imaging an object with a camera, you can use SSAG to accurately autoguide the telescope through the exposure.

After you complete the alignment and center calibration, you can initiate autoguiding by pressing the MENU button and using the SCROLL keys to select "SSAG." Press ENTER. Then use the SCROLL keys to choose "Guiding" and press ENTER.

The hand control's LCD will display a screen like Fig. 12. The numbers on the top line represent the right ascension (RA) RMS tracking error, and the numbers on the bottom line represent the declination (Dec) RMS tracking error in arcseconds. The +/- symbols to the right of the RA and Dec RMS tracking errors indicate the direction of the previous tracking command on that axis. The "s" number is the number of stars SSAG is using for guiding. The "Q" number represents the quality of the guiding, which is essentially a measurement of the local seeing conditions—zero is poor while 100 is ideal. The blinking asterisk next to the Q number indicates that the hand control is receiving guiding commands from SSAG.

SSAG will continue guiding indefinitely. When you are ready to stop guiding, press the BACK button. (While autoguiding, none of the hand control's buttons will work except the BACK button.)

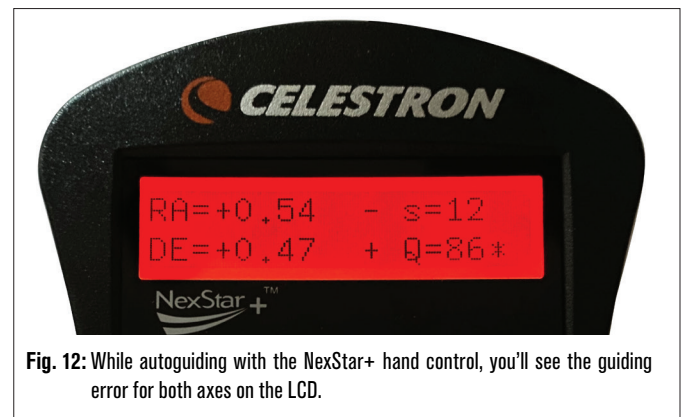

Fig. 12: While autoguiding with the NexStar+ hand control, you'll see the guiding error for both axes on the LCD.

Polar Alignment

Although your equatorial mount does not need to be accurately polar aligned to use SSAG, SSAG can help you achieve a very accurate polar alignment. A precise polar alignment slightly improves overall pointing accuracy—but only by a few arcminutes. If you choose to polar align, do so before sky alignment and center calibration. Keep in mind that only equatorial mounts or AZ mounts using EQ wedges can be polar aligned.

NOTE: These instructions explain how to perform the polar alignment procedure in the Northern Hemisphere. If you are in the Southern Hemisphere, always point your mount due South instead of due North.

To perform a polar alignment with SSAG:

1. Roughly polar aligning your mount first will make the entire process quicker and easier. Once you are roughly aligned, you can achieve an accurate polar alignment using only the mount's altitude and azimuth fine adjustment knobs.

- a. Make sure the mount is reasonably level. If your mount has a bubble level built in, use that for reference.
- b. Adjust the altitude of the mount so that the mount's latitude scale indicates roughly the same latitude as your observing site.
- c. Lift and rotate the entire tripod and mount so that the right ascension (RA) axis points approximately due North. The

mount's position doesn't need to be perfect. Aim within about 5° due North so the mount is within the range of the mount's azimuth fine adjustment knobs. Use a free compass app for your smartphone if you need help finding North.

d. If you loosened the altitude or azimuth adjustment knobs during rough polar alignment, make sure they are retightened before continuing.

2. Press the MENU button and use the SCROLL keys to navigate to the SSAG menu. Then press ENTER.
3. Use the SCROLL keys to select "Polar Align." Press ENTER.
4. The hand control will ask you to slew the telescope to a clear area of the sky. Use the hand control's direction keys to point to a clear location. Press ENTER.
 - The telescope will slew from West to East for about 50° during the polar alignment process. Try to choose a clear area that provides a clear path.
5. The telescope will slew from West to East to obtain polar alignment references. This will take a few minutes.
6. When the telescope stops slewing, the hand control will display "Adjust AZM." Press ENTER. The LCD will now show the AZM and ALT polar alignment errors.
7. If your mount has an azimuth axis lock knob or locking screws, loosen them before adjusting the azimuth.
8. Use the mount's azimuth fine adjustment knobs to adjust the mount's azimuth (left-to-right) positioning slowly. As you make these adjustments, the AZM error will increase or decrease. Continue adjusting until the AZM error is below two arcminutes. Press ENTER.
 - Do not adjust the altitude of the mount! You will make altitude adjustments in the next step.
 - Make the adjustments slowly so SSAG can track them. If you adjust too quickly and SSAG loses track, you'll need to restart the entire polar alignment process.
9. The hand control will now display "Adjust ALT." Press ENTER.
10. If your mount has altitude axis lock knobs, loosen them before adjusting altitude.
11. Use the mount's altitude fine adjustment knobs to adjust the mount's altitude (up-and-down) positioning slowly. As you make these adjustments, the ALT error will increase or decrease. Continue adjusting until the ALT error is below two arcminutes. Press ENTER.
 - Do not adjust the azimuth of the mount.
12. The hand control will now ask, "Fine Adjust AZM?"
 - a. If you wish to make additional adjustments to the azimuth, use the SCROLL keys to select "Yes" and press ENTER. Adjust until the error is less than two arcminutes, and press ENTER.
 - b. If you do not want to make further adjustments, use the SCROLL keys to select "No" and press ENTER.
13. Congratulations! You have successfully polar-aligned your mount. If your mount has altitude or azimuth locking knobs or screws, tighten them firmly. For best results, do sky alignment after polar alignment. If you have already done a sky alignment, then we recommend power cycling and performing sky alignment again.

NOTE: Don't attempt to adjust the polar alignment to better than two arcminutes on each axis. Doing so will be difficult and will not provide additional pointing or tracking benefits. In many cases, autoguiding performance may actually be better with a slight polar alignment error.

Other Functionality

You can access all the additional options below by pressing the MENU button, using the SCROLL keys to select "SSAG," and pressing ENTER. Refer to Fig. 13 for the SSAG menu tree.

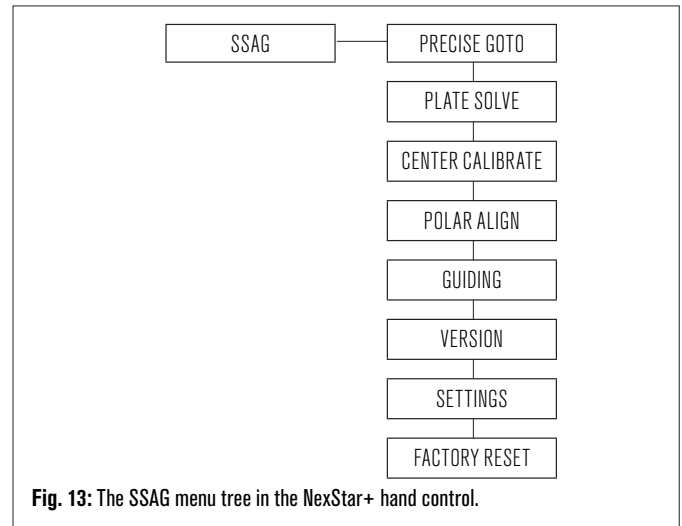

Fig. 13: The SSAG menu tree in the NexStar+ hand control.

Precise GoTo

Precise GoTo uses SSAG to more accurately center objects in the field of view. When this option is enabled, the telescope mount uses its internal alignment model to find and center the object as usual; this should generally place the object somewhere in the field of view. Then SSAG takes over, making fine corrections to the centering, significantly improving the overall pointing accuracy. When you are using SSAG, Precise GoTo is enabled by default, so you do not need to initiate a Precise GoTo here. However, if you have turned Precise GoTo off (see Settings section below), you can initiate a Precise GoTo to a specific object from this menu selection.

Plate Solve

When you choose this option, SSAG will capture an image and plate solve. The hand control will display the center coordinates (RA and Dec) to which the telescope is pointing in the sky.

Version

Selecting this option displays the current version number of SSAG's internal software.

- To view the NexStar+ hand control firmware version, select the "Version" option from MENU>Utilities.

Settings

Use Precise GoTo – This setting allows you to enable or disable automatic Precise GoTo after every slew. Precise GoTo is on by default for the best pointing accuracy. However, this feature causes the telescope to take slightly longer to center objects. We recommend that most users leave Precise GoTo on.

Factory Reset

A factory reset power cycles SSAG and clears the device of any previous center calibration data. When you turn on SSAG after a Factory Reset, it will automatically initiate a new center calibration after sky alignment.

5. Using SSAG with CPWI

If you already use a PC to control your telescope (e.g., for astrophotography), Celestron's free CPWI software is a great way to control SSAG. Its intuitive user interface makes accessing all of SSAG's features easy.

StarSense Alignment

After you connect CPWI to your Celestron mount and SSAG as described previously, the Alignment window will appear (Fig. 14) so you can select a method to align your mount with the night sky. But first, check the date, time, and location near the top of the window. If you notice any mistakes, click the “Set Time” or “Set Location” buttons to adjust.



Fig. 14: The SSAG alignment window in CPWI.

If you are using an AZ mount with an EQ Wedge, select the “EQ Wedge” option that appears in the top right of the Alignment window. Selecting this will treat the AZ mount as an EQ mount.

For completely automatic alignment, choose “StarSense Alignment,” then press the “Begin Alignment” button. The Pointing Model Information will appear (Fig. 15). In the “Home Switches” section, CPWI asks, “Is the mount ready to move to the home switches?” If your mount has home switches (e.g., CGX and CGX-L), click “Ready,” and the telescope will move to its home switches. If your mount does not have home switches but has index marks, manually move the telescope to its index marks.

If you are using an AZ mount, CPWI will ask you to point your telescope toward the Northern horizon (i.e. tube horizontal and pointing North). Point the telescope to the southern horizon if you are in the Southern Hemisphere. Use the Mount Slew Controls window that appears onscreen to do this. You don’t need to be precise with this step; it’s only an initial position for the alignment routine.

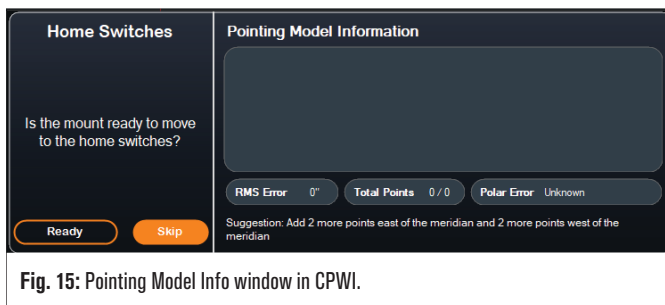

Fig. 15: Pointing Model Info window in CPWI.

If you have not center calibrated your SSAG previously, you should do so before sky alignment when prompted by CPWI. Unlike the NexStar+ hand control, CPWI requires you to perform center calibration before sky alignment. Otherwise, you will need to perform the sky alignment again. Please refer to the “Center Calibration” section on page 8.

Next, if you are using an EQ mount or AZ mount on an EQ wedge, CPWI will ask if you would like to polar align. (If you want to polar align your mount, now is the best time. If you polar align after sky alignment, you’ll need to perform sky alignment again.) To polar align, click “Yes” and follow the instructions in the Polar Align section on page 8. If you choose not to polar align, click “No” to move on to sky alignment. You can always

polar align later by selecting the “Polar Align Mount” option from the StarSense AG menu.

NOTE: Remember, in many cases, you will not need to accurately polar align your mount to use SSAG, including for autoguiding.

After polar alignment, the window will display “StarSense Alignment” and prompt you to select an alignment option (Fig. 16).

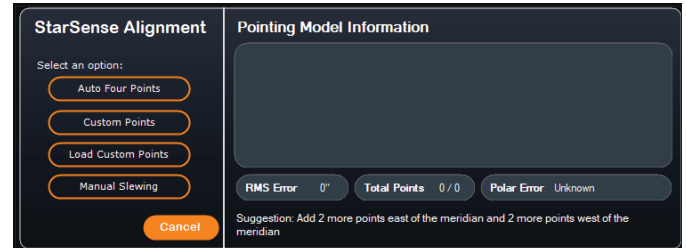

Fig. 16: StarSense Alignment options in CPWI.

Auto Four Points

Auto Four Points is the most automated alignment choice. SSAG will automatically slew to four points in the sky to achieve sky alignment. If it points to an obstruction or otherwise fails to determine its position, the telescope will simply slew to another point in the sky to obtain another alignment reference.

Custom Points

Custom Points allows you to define points in the sky where the telescope slews for alignment. It’s a good choice if your observing site has local obstructions because you can define the alignment points so that the telescope steers clear of them. If you choose this option, the StarSense User Interface Auto Alignment Creator window will appear (Fig. 17).

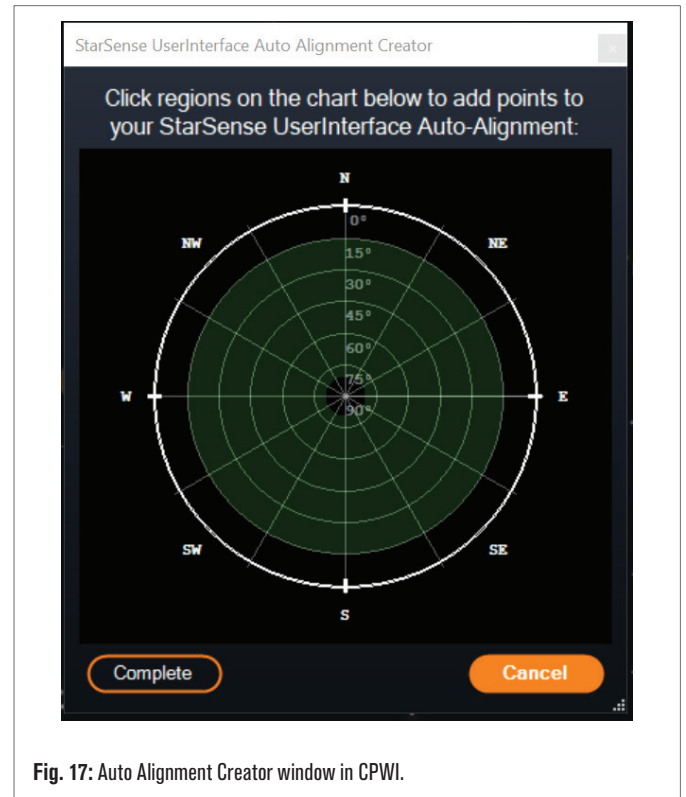

Fig. 17: Auto Alignment Creator window in CPWI.

Click within the chart to select alignment points in the sky. You’ll find the cardinal directions on the perimeter of the chart. The interior of the chart goes from 0° altitude (i.e., the horizon) at the edge to 90° (i.e., zenith) at the center. You can choose more than four alignment points if you wish. For the best results, choose points spaced widely apart and avoid

points near the poles for EQ mounts. After selecting alignment points, click “Complete” in the bottom left of the window. Before CPWI begins the alignment, it will ask if you want to save your user-defined alignment points. If you do, you can use the .sua file later with the “Load Custom Points” option.

Load Custom Points

Once you have defined “Custom Points” as described above, you can choose this option to use them again. Select the .sua file you created previously, and alignment will automatically begin.

Manual Slewing

With this alignment option, you use the Mount Slew Controls window to manually slew SSAG to a clear area of the sky and click “Solve Here” to obtain an alignment reference. Repeat the process four times, and alignment is complete. This is the least automated choice, but it can be helpful if your observing site has obstructions or the sky is partly cloudy. For best results, use four alignment points that are as widely spaced as possible and avoid points near the poles for EQ mounts.

Adding Additional Alignment References

After alignment, you can see the information about the mount’s generated pointing model, including the RMS error, the total number of points in the alignment model, and the calculated polar alignment error.

You can add additional alignment references throughout the night by selecting an object in the planetarium view, clicking on it, and choosing “Model.” The mount will slew to the object’s location, and SSAG will add the alignment reference to the mount’s pointing model. Pointing accuracy should be quite good with only four points, but it will generally increase with each alignment reference you add.

If you have never performed a center calibration with your telescope and SSAG, CPWI will prompt you to do so after sky alignment.

Center Calibrate

Center calibration aligns SSAG’s field of view with that of your telescope. You’ll generally only need to center-calibrate the first time you use SSAG with a new telescope tube. However, you may need to center-calibrate again if you remove the bracket base from the telescope and then reinstall the bracket. If you only remove SSAG and its bracket, leaving the bracket base on the telescope, you should not need to center-calibrate again.

If you have not center-calibrated previously, SSAG will automatically initiate a center calibration **before** sky alignment. If you want to center-calibrate later, choose “Center Calibrate” from the StarSense AG menu.

To do a center calibration:

1. Select an object in the SkyViewer planetarium screen by clicking on it. Choose a bright star or planet that is clearly visible from your observing location.
2. The telescope will now slew to the selected object. Depending on the offset between SSAG’s field of view and the telescope’s, the object may or may not be in the telescope’s field of view. In any case, the telescope should be pointing toward the object.
3. CPWI will prompt you to center the object in the field of view of the telescope’s eyepiece. You can use the onscreen Mount Slew Controls window. When you are finished, click “Centered” in the Pointing Model Information window.
 - If the star is not within the field of view of the finderscope, slew manually until it is.
 - If you are not using a finderscope, use your widest-field eyepiece to find the object instead. If the object is not in the eyepiece’s field of view, sight down the length of the telescope tube to point it to the object.
 - For final centering, use a high-powered eyepiece.
 - When centering the star in the telescope’s field of view, use the up and right direction keys last.

4. SSAG will perform the center calibration and return the message “Center Calib Success.”

Once you’ve completed Auto Align and Center Calibration, you can command the telescope to accurately place any celestial object you choose within the telescope’s field of view.

Polar Alignment

Although your EQ mount (or AZ mount on EQ wedge) does not need to be polar aligned to use SSAG, SSAG can help you achieve a very accurate polar alignment. A precise polar alignment slightly improves overall pointing accuracy—but only by a few arcminutes. If you choose to polar align, do so before sky alignment. If you wish to polar align later, you can select the “Polar Align Mount” option in the SSAG menu.

NOTE: These instructions explain how to perform the polar alignment procedure in the Northern Hemisphere. If you are in the Southern Hemisphere, always point your mount due South instead of due North.

To perform a polar alignment with SSAG through CPWI:

1. Roughly polar aligning your mount first will make the entire process quicker and easier. Once you are roughly aligned, you can achieve an accurate polar alignment using only the mount’s altitude and azimuth fine adjustment knobs.
 - a. Make sure the mount is reasonably level. If your mount has a bubble level built in, use that for reference.
 - b. Adjust the altitude of the mount so that the mount’s latitude scale indicates roughly the same latitude as your observing site.
 - c. Lift and rotate the entire tripod and mount so that the right ascension (RA) axis points approximately due North. The mount’s position doesn’t need to be perfect. Aim within about 5° due North so the mount is within the range of the mount’s azimuth fine adjustment knobs. Use a free compass app for your smartphone if you need help finding North.
 - d. If you loosened the altitude or azimuth adjustment knobs during rough polar alignment, make sure they are retightened before continuing.
2. Manually slew the telescope to an initial start position using the Mount Slew Controls window.
 - The telescope will slew from West to East for about 50° during the polar alignment process. Try to choose a clear area that provides a clear path.
3. Click “Begin” in the SSAG Polar Alignment section of the Pointing Model Information window. The mount will slew East, stopping about every 10° to obtain a polar alignment reference.
4. After SSAG has obtained its polar alignment references, it will display the azimuth axis adjustment window (Fig. 18). Slowly fine-adjust your mount’s azimuth until the “Azm Error” is less than two arcminutes.
 - If the mount has azimuth axis locks, loosen them first.
 - Make the adjustments slowly so SSAG can track them. If you adjust too quickly and SSAG loses track, you’ll need to restart the entire polar alignment process.

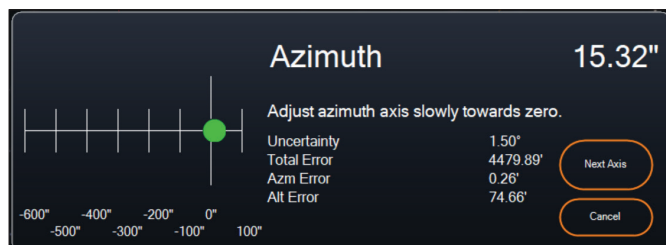

Fig. 18: Azimuth Axis Adjustment window during polar alignment in CPWI.

5. Click “Next Axis” when you are done making adjustments to the azimuth. The Altitude axis adjustment window will appear (Fig. 19).

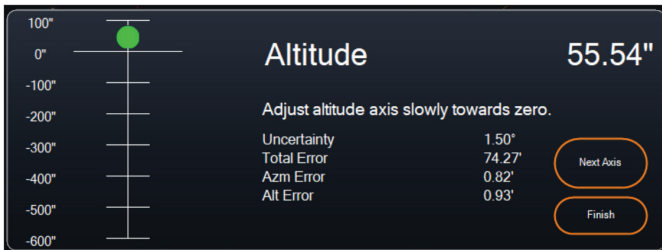

Fig. 19: Altitude Axis Adjustment window during polar alignment in CPWI.

6. Slowly fine-adjust your mount's altitude until the "Alt Error" is less than two arcminutes.
 - If the mount has altitude axis locks, loosen them first.
7. If you would like to readjust the azimuth axis, click "Next Axis." Otherwise, click "Finish."
8. Congratulations! You have successfully polar-aligned your mount. If your mount has altitude or azimuth locking knobs or screws, tighten them firmly. For best results, do sky alignment after polar alignment. If you have already done a sky alignment, then delete the current alignment from the Alignment menu and perform sky alignment again.

NOTE: Don't attempt to adjust the polar alignment to better than two arcminutes on each axis. Doing so will be difficult and will not provide additional pointing or tracking benefits. In many cases, autoguiding performance may actually be better with a slight polar alignment error.

Autoguiding

After sky alignment is complete, SSAG is ready for autoguiding. Simply slew to the object you wish to image, then turn on the "Guiding Enabled" option in the SSAG menu. The SSAG will then provide guiding corrections to your mount automatically. To see the autoguiding corrections, you can select "Guider Graphs" from the SSAG menu. A graph will appear showing the error corrections over time.

NOTE: Keep in mind that overall autoguiding performance relies on many different factors, including the load on the mount, your mount's balance (i.e., your mount must be well balanced along both axes), and local seeing conditions.

You'll need to turn guiding on again after slewing to a new object, as the SSAG needs to recalibrate itself before it can begin guiding on the new object.

Dithering

In the SSAG menu under Settings (Fig. 20), CPWI offers dithering options to use with your camera control software when autoguiding. Dithering moves the telescope very slightly between exposures, helping to make image processing noise reduction techniques more effective. You'll need to connect your camera software to CPWI via the ASCOM driver built into CPWI to use this feature. After you enable dithering in CPWI, you can set the minimum dithering distance (from 0 to 10") and the maximum dithering distance (20" to 50"). For some camera control software, you may also need to enable "PHD Mode" in the SSAG menu.

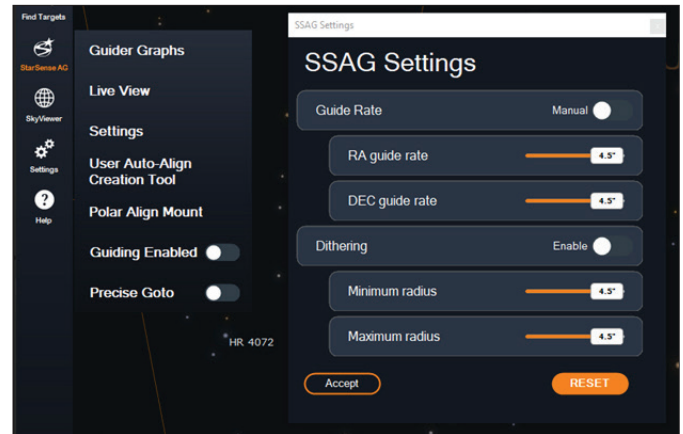

Fig. 20: You can enable dithering, adjust parameters, and manually adjust guide rates in the Settings section.

Guide Rate

Normally, you do not need to manually adjust the guide rates for autoguiding (i.e., the distance the mount moves with each SSAG guide command). However, suppose your mount is not autoguiding well in one or both axes. In that case, try manually adjusting the guide rates from the Settings section of the SSAG menu (Fig. 20). First, turn on Manual settings for Guide Rate, then adjust the guide rate for each axis using the sliders. Use trial and error to determine your mount's best manual guide rate settings.

Other Functionality

Live View

The Live View window displays a live readout from SSAG's image sensor. Its primary purpose is to aid in focusing SSAG's lens (see the section on Focusing later in this manual), but it can also be interesting to see what SSAG is seeing. Note the sharp stars across the field of view due to the excellent optical design of the lens.

To see the Live View, you'll need to connect SSAG directly to your PC using a USB Type-A to USB Type-C cable (not supplied). This is because the AUX interface cannot support the transfer of images. You'll also need to install the SSAG driver on your computer. You'll find it in the Support & Downloads section of the StarSense Autoguider (#94008) product page at celestron.com.

Once you install the driver and connect SSAG with the USB cable, the Live View window will display the current view from SSAG's image sensor. There are no controls for the Live View. SSAG automatically adjusts exposure and gain to obtain the best images.

NOTE: You should still connect SSAG to the mount via AUX while it is connected to the PC via USB for Live View.

Precise GoTo

Precise GoTo uses SSAG to more accurately center objects in the field of view. When this option is enabled, the telescope mount uses its internal alignment model to find and center the object as usual; this should generally place the object somewhere in the field of view. Then SSAG takes over, making fine corrections to the centering, significantly improving the overall pointing accuracy. When you are using SSAG, Precise GoTo is enabled by default. If you want to turn this feature off, you can do so from the StarSense AG menu.

Version

Selecting this option displays the current version of SSAG's firmware.

Factory Reset

A factory reset power cycles SSAG and clears the device of any previous center calibration data. When you turn on SSAG after a Factory Reset, it will automatically initiate a new center calibration after sky alignment.

6. Focusing

Technicians at the factory have focused your StarSense Autoguider, and it should not need further adjustment. However, if you find that SSAG is not working as it should (e.g., reporting “No Stars!” when there are plenty of stars visible in the sky), you should check the focus.

To focus StarSense Autoguider:

1. Follow the process outlined above to access the Live View in CPWI.
2. If you are focusing during the day, point SSAG at an object at least a quarter mile away. If you are focusing at night, point SSAG at a bright star. You should see an image onscreen.

NOTE: If you are attempting to focus during very bright daytime conditions, try adding a 2" neutral density filter to dim the view. Refer to the Using Filters section later in this manual for more details.

3. If the focus is sharp, you are done. If not, remove SSAG's front cover by grasping it and rotating it counterclockwise until it comes off (Fig. 21). Only remove the front cover, not the entire front of the housing.

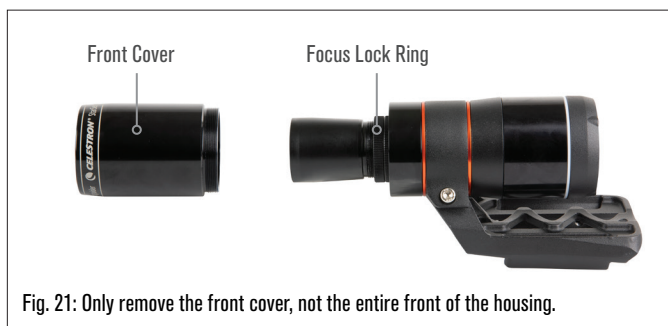

Fig. 21: Only remove the front cover, not the entire front of the housing.

4. Loosen the focus lock ring (Fig. 22).



Fig. 22: Loosen the lock ring when making focus adjustments, then firmly retighten when focused.

5. Rotate the optics clockwise by a quarter- to half-turn to see if focus improves. If it does, continue rotating until the focus is as sharp as possible. If the focus does not improve, rotate the optics counterclockwise until the focus improves.

6. When you see a sharp image, retighten the lock ring and reinstall SSAG's front cover. If desired, you can now disconnect SSAG from the PC's USB port.

7. Status LED Ring

Toward the rear of the SSAG enclosure, you'll find the LED status ring (Fig. 23). The status ring illuminates when you connect SSAG to a Celestron mount that is powered on. The ring provides “at a glance” status messaging for SSAG.

The status ring has three modes:

Steady on: SSAG is receiving power and idle.

Quick pulsing: SSAG is calculating a plate solve.

Pulse: SSAG has executed a guide correction during autoguiding.

Constant blinking that never stops: Contact Celestron Technical Support at celestron.com/pages/technical-support



Fig. 23: The LED ring indicates SSAG's status at a glance.

8. Using Filters

SSAG's front housing is threaded to accept standard 2" filters (Fig. 24). The most helpful filter to pair with your SSAG is an IR-pass filter that blocks most visible wavelengths (400-700nm) but passes wavelengths above 700nm. With this filter, you can align your telescope with SSAG during twilight. Even though you won't be able to see stars with your eyes, SSAG will detect the near-infrared wavelengths and align your telescope before it even gets dark! A 2" neutral density filter or Moon filter can reduce excessive brightness when adjusting SSAG's focus during the day.



Fig. 24: You can mount standard 2" filters onto the front of SSAG.

9. Updating SSAG's Internal Software with CFM

Our engineers are constantly working on upgrades and improvements to our products, so we recommend periodically checking for SSAG internal software updates at celestron.com/CFM. If a new SSAG software update is available, you can download and install it with the Celestron Firmware Manager (CFM) software. Follow these steps to update SSAG's software:

1. Set up as you usually would, with the NexStar+ hand control and SSAG plugged into the mount's AUX ports.
2. Power on the mount.
3. Connect the USB port on the bottom of the hand control to your PC. You'll need a USB Type-A to USB Mini-B cable (not supplied). The computer should recognize the mount.

4. Run CFM. It should find the hand control and the StarSense Autoguider.
5. Click the Update button in CFM. CFM will install any available updates for both SSAG and the hand control.

10. Updating SSAG's Internal Software and Live View via Web Interface

Alternatively, you can update SSAG's software directly via USB. This method does not use CFM and does not update the hand control. If any new firmware is available, you'll find it as a .swu file on the StarSense Autoguider (#94008) page at celestron.com. To install the file, you'll need a USB Type-A to USB Type-C cable (not supplied) and the SSAG PC driver, also available on the StarSense Autoguider page at celestron.com.

Follow these steps to update SSAG's software:

1. Install the SSAG driver on your PC.
2. Connect SSAG to your PC via the USB cable. After about 10 seconds, SSAG's LED ring will illuminate, indicating it is receiving power via USB.
3. Open a web browser on your computer and enter <http://169.254.54.1/> to launch the SSAG web interface page (Fig. 25).

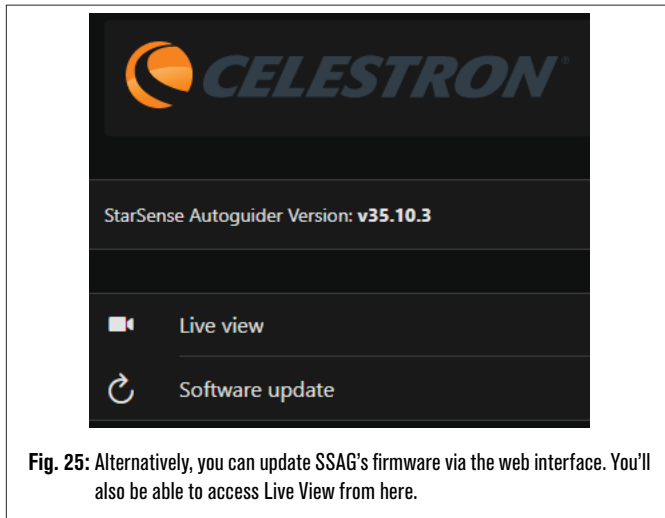

Fig. 25: Alternatively, you can update SSAG's firmware via the web interface. You'll also be able to access Live View from here.

4. Select "Software Update."
5. Drag and drop the downloaded .swu file as directed. SSAG's software will update.

You can also access the SSAG Live View from this web interface. You'll have controls to change from automatic to manual camera settings and can even capture an image (TIFF format) here.

11. Troubleshooting and Tips

1. If you continually get the "No Stars!" error message during plate-solving when the sky is clear, try refocusing SSAG.
2. If the Moon is high and bright in the sky, SSAG may have trouble plate-solving within a few degrees of the Moon due to the intense glare. You may receive a "No Stars!" error message.
 - a. If there is a light haze in the sky, SSAG may have trouble plate-solving even farther away from the Moon.
 - b. An IR-pass filter can help reduce the Moon's glare.
3. For the best overall performance, we recommend leveling your tripod. SSAG will still work with a tripod that is not level, but its pointing accuracy will be somewhat diminished.

4. For the most accurate Precise GoTo functionality, polar align your mount. Precise GoTo will still work well if your mount is not polar aligned, but overall accuracy will be slightly reduced—typically by several arcminutes.
5. For the best guiding performance, disable all backlash compensation and periodic error correction (PEC) in the hand control or CPWI. This prevents any conflicts between the SSAG's guide commands and backlash/PEC settings.
6. SSAG has a built-in lens shade that will help prevent dew from forming on its optics. Under heavy dew conditions, however, you may consider adding a third-party heater strip along with a Celestron Smart DewHeater Controller to keep dew off the SSAG's lens.
7. If you are using a USB cable to connect SSAG to your PC, make sure it is a high-quality cable. If you have trouble connecting to SSAG via USB, try another USB cable or another USB port on your computer.
8. When autoguiding with CPWI on a PC, you can try connecting the PC directly to SSAG's USB-C port (with SSAG still connected to the mount via the AUX cable). This may improve performance because the USB-C port handles autoguiding commands faster than the AUX port can.

12. Specifications

LENS

DESIGN	Double-Gauss
CLEAR APERTURE	31mm
EFFECTIVE APERTURE	28mm
FOCAL LENGTH	120mm
EFFECTIVE FOCAL RATIO	f/4.3
NUMBER OF ELEMENTS	4
COATINGS	Fully multi-coated

CMOS IMAGE SENSOR

CMOS IMAGE SENSOR	Sony IMX290LLR, monochrome, back-illuminated
SENSOR SIZE	6.46mm diagonal
PIXEL SIZE	2.9µm x 2.9µm
NUMBER OF EFFECTIVE PIXELS	2.13 M

ONBOARD COMPUTER

PRIMARY ARM® CORE	2x Cortex® -A53 up to 1.4 GHz
SECONDARY ARM® CORE	1x Cortex-M7 up to 600 MHz
RAM	512 MB
ROM	4 GB
GPU	GC7000UltraLite
OPERATING TEMPERATURE	-25°C to 85°C

PORTS

AUX:	For connection to Celestron mounts
USB-C	For PC connection to focus, see Live View, and update firmware

HOUSING

HOUSING	Aluminum with plastic covers, threads for 2" filters
---------	--

FCC NOTE: This equipment has been tested and found to comply with the limits for a Class B digital device, pursuant to part 15 of the FCC Rules. These limits are designed to provide reasonable protection against harmful interference in a residential installation. This equipment generates, uses, and can radiate radio frequency energy and, if not installed and used in accordance with the instructions, may cause harmful interference to radio communications. However, there is no guarantee that interference will not occur in a particular installation. If this equipment does cause harmful interference to radio or television reception, which can be determined by turning the equipment off and on, the user is encouraged to try to correct the interference by one or more of the following measures:

- Reorient or relocate the receiving antenna.
- Increase the separation between the equipment and receiver.
- Connect the equipment into an outlet on a circuit different from that to which the receiver is connected.
- Consult the dealer or an experienced radio/TV technician for help.

Product design and specifications are subject to change without prior notification.
This product is designed and intended for use by those 14 years of age and older.



©2023 Celestron. Celestron and Symbol are trademarks of Celestron, LLC.
All rights reserved. [Celestron.com](https://www.celestron.com)

[celestron.com/pages/technical-support](https://www.celestron.com/pages/technical-support)

2835 Columbia Street • Torrance, CA 90503 U.S.A.



[celestron.com/pages/warranty](https://www.celestron.com/pages/warranty)

Inverkehrbringer und Service für Deutschland und Österreich:
Baader Planetarium GmbH – Zur Sternwarte - 82291 Mammendorf – Tel.: 08145/80890 - service@celestron-deutschland.de